

# Agilent Designing and Testing 3GPP W-CDMA Base Transceiver Stations (Including Femtocells)

Application Note 1355

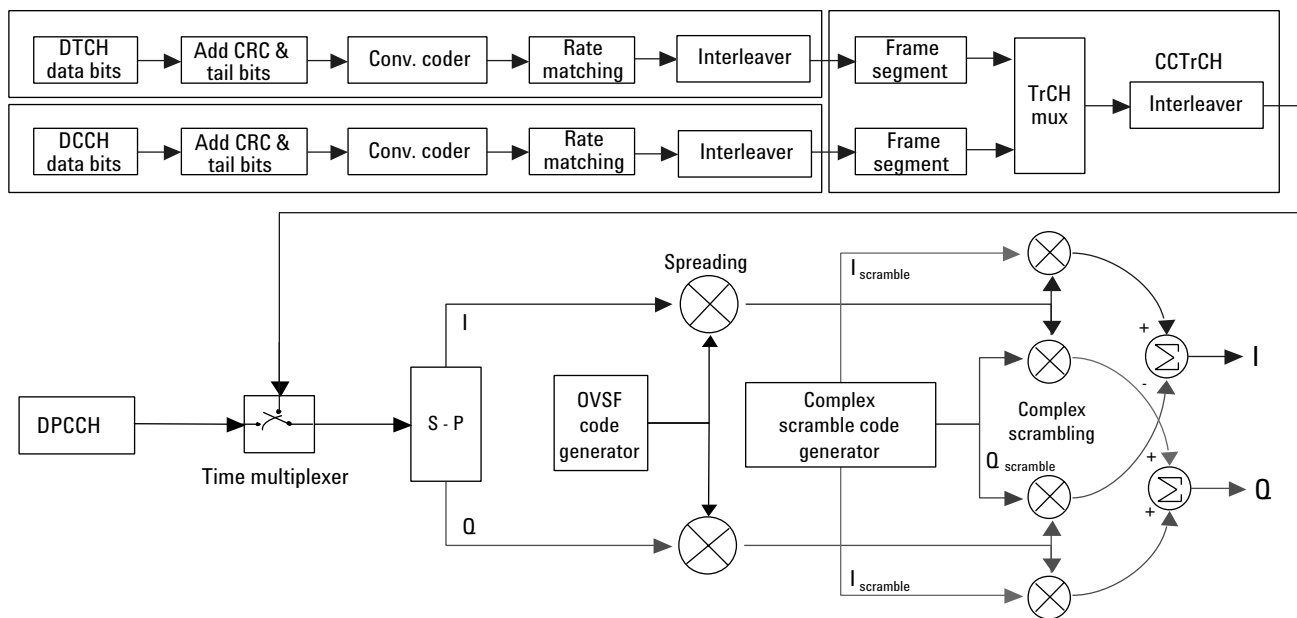

# Table of Contents

<b>Introduction</b> .....	<b>3</b>
<b>1. Basic Concepts of W-CDMA</b> .....	<b>4</b>
1.1 Code division multiple access .....	4
1.2 Base transceiver station and user equipment identification .....	5
1.3 Data channelization .....	5
1.4 Slots, frames, and power control .....	7
1.5 Protocol structure .....	7
1.6 Logical, transport, and physical channels .....	8
1.7 Downlink physical channels .....	9
1.8 Uplink physical channels .....	11
1.9 Transport format detection .....	14
1.10 Downlink DPDCH/DPCCH coding and air interface .....	15
1.11 Uplink DPDCH/DPCCH coding and air interface .....	16
1.12 Test models and reference measurement channels .....	17
1.13 Fixed reference measurement channels .....	18
1.14 Compressed mode .....	18
1.15 Asynchronous cell site acquisition .....	18
1.16 Asynchronous cell site soft handover .....	19
<b>2. General Design and Measurement Issues</b> .....	<b>20</b>
2.1 Controlling interference .....	20
2.1.1 Average RF power .....	21
2.1.2 Adjacent channel interference .....	22
2.2 Handling high peak-to-average power ratios .....	23
2.2.1 Complementary cumulative distribution function .....	24
2.3 Measuring modulation quality .....	26
2.3.1 QPSK EVM .....	27
2.3.2 Composite EVM .....	29
2.3.3 Code domain power .....	31
2.3.4 Peak code domain error .....	33
2.3.5 Symbol EVM .....	34
2.3.6 Symbol power versus time .....	36
2.3.7 Demodulated bits .....	37
2.3.8 Power control in the downlink .....	38
2.4 Measuring receiver performance .....	39
2.4.1 Bit error rate (BER) versus block error rate (BLER) .....	40
2.4.2 Stimulus signals for receiver characteristics and performance tests .....	42
2.4.3 Verification of internal BER and internal BLER calculation .....	44
2.4.4 Verifying RF performance .....	44
2.4.5 Verifying baseband functionality .....	45
2.4.6 Verification of compressed mode functionality .....	45
2.4.7 Verification of PRACH reception .....	46
2.4.8 Verification of uplink power control .....	47
<b>3. Special Considerations for Femtocells</b> .....	<b>48</b>
3.1 Additional test requirements for GPS-enabled femtocells .....	49
<b>Summary</b> .....	<b>49</b>
<b>Appendix A: Conformance Test Setup Tables</b> .....	<b>50</b>
<b>Appendix B: Agilent Solutions for W-CDMA BTS Design and Test</b> .....	<b>52</b>
<b>Acronym Glossary</b> .....	<b>62</b>
<b>References</b> .....	<b>63</b>
<b>Related Literature</b> .....	<b>63</b>

# Introduction

W-CDMA is the leading wideband digital cellular technology used for the third generation (3G) cellular market.

The Third Generation Partnership Project (3GPP) system employs wideband CDMA in both frequency division duplex (FDD) and time division duplex (TDD) modes. To limit its scope, this application note focuses on the FDD mode of W-CDMA, although most of the content is applicable to both modes. Whenever the term W-CDMA is used throughout the application note it is in reference to the 3GPP (Release 99) specifications for W-CDMA FDD mode. Specific reference to later releases of the specifications are made when appropriate.

This application note focuses on the physical layer (layer 1) aspects of W-CDMA base transceiver stations (BTS). It consists of

- a brief overview of W-CDMA technology
- a discussion of design issues and measurement concepts related to the technology that are important for the W-CDMA BTS air interface because of the differences between W-CDMA and its second generation (2G) predecessors (specifically the Global System for Mobile Communication (GSM)). This section will provide you with an understanding of why these measurements are important and how you can use them to characterize and troubleshoot designs. These measurements can be useful throughout the development of the BTS. This section can also be used as background information for conformance tests.
- a discussion on the specific requirements of a new class of base station that has recently emerged – the femtocell. Femtocells (3GPP Home Node B for W-CDMA/HSPA) are low-power wireless access points that connect standard mobile devices to a mobile operator's network via residential DSL or cable broadband. While a compelling entrant into the broadband CPE (Consumer Premises Equipment) market dominated by Wireless LANs, femtocells are forcing manufacturers to confront a number of new test considerations. Since they operate in the licensed spectrum, they face the same stringent conformance requirements as normal base stations; although the costs (and hence allowable test times) are much lower and volumes are many times higher.
- a table with an overview of the BTS transmitter, receiver, and performance conformance tests required by the 3GPP specifications. For detailed specifications, see **[www.3gpp.org/specifications](http://www.3gpp.org/specifications)**. In many cases, the tests are based on the more general measurements described previously. This table can be used as a quick guideline on what measurement and equipment to use for each test.
- a list of Agilent Technologies' solutions for the physical layer of W-CDMA BTS design and test

You can find further information about 3G technologies at the following URL:

**<http://www.agilent.com/find/3G>**

# 1. Basic Concepts of W-CDMA

W-CDMA is designed to allow many users to efficiently share the same RF carrier by dynamically reassigning data rates and link budget to precisely match the demand of each user in the system. Unlike some 2G and 3G CDMA systems, W-CDMA does not require an external time synchronization source such as the Global Positioning System (GPS).

## 1.1 Code division multiple access

As its name implies, W-CDMA is a code division multiple access (CDMA) system. As opposed to time division multiple access (TDMA), in CDMA, all users transmit at the same time. Frequency divisions are still used, but at a much larger bandwidth. In addition, multiple users share the same frequency carrier. Each user's signal uses a unique code that appears to be noise to all except the correct receiver. Therefore, the term *channel* describes a combination of carrier frequency and code. Correlation techniques allow a receiver to decode one signal among many that are transmitted on the same carrier at the same time. Figure 1 shows a simplified version of the transmission and reception processes for a CDMA system. This example uses W-CDMA data-rate and bandwidth parameters, although the basic processes are the same for all CDMA systems.

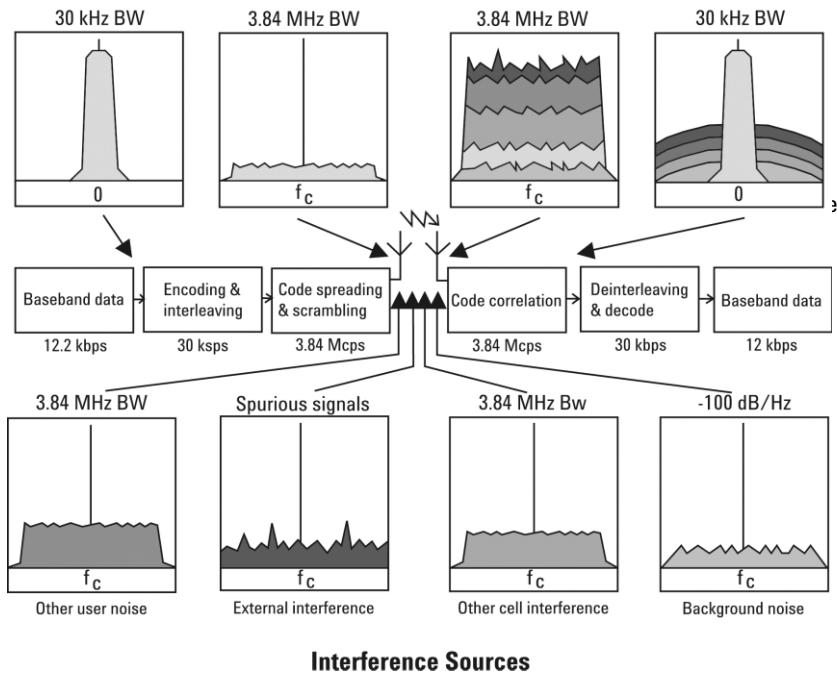

**Figure 1. CDMA transmission and reception processes**

In Figure 1, the W-CDMA system starts with a narrowband signal at a data rate of 12.2 kbps. In reality, this data rate is variable, up to 2 Mbps. After coding and interleaving, the resulting symbol rate in this example is 30 kbps. This is spread with the use of specialized codes to a bandwidth of 3.84 MHz. The final spread bits are called chips, and the final spread rate is defined in terms of chips per second (3.84 Mcps for W-CDMA). The ratio of the spread data rate (3.84 Mcps) to the encoded data rate (30 kbps in this case) is called the spreading gain. The ratio of the spread data rate to the initial data rate (12.2 kbps in this case) is called the processing

gain. In CDMA systems the spreading gain is a big contributor to the processing gain. The processing gain allows the receiver's correlator to extract the desired signal from the noise. When transmitted, a CDMA signal experiences high levels of interference, dominated by the signals of other CDMA users. This takes two forms, interference from other users in the same cell and interference from adjacent cells. The total interference also includes background noise and other spurious signals. When the signal is received, the correlator recovers the desired signal and rejects the interference. This is possible because the interference sources are uncorrelated to each channel's unique code. In W-CDMA, the unique code for each channel is a combination of the scrambling code and the orthogonal variable spreading factor (OVSF) code, which are described in the following sections.

## 1.2 Base transceiver station and user equipment (UE)<sup>1</sup> identification

As in other CDMA systems, in W-CDMA each BTS output signal is scrambled by multiplying all of its data channels by a unique pseudo-noise (PN) code, referred to in the W-CDMA specification as a scrambling code. A UE receiver can distinguish one BTS from another by correlating the received signal spectrum with a scrambling code that is identical to that used in the desired BTS. Similarly, each UE output signal is scrambled with a unique scrambling code that allows the BTS receiver to discern one UE from another. The scrambling codes are applied at a fixed rate of 3.840 Mcps. The scrambling codes are not orthogonal. Therefore, some interference can exist between two UEs.

## 1.3 Data channelization

Besides distinguishing which transmitter is being listened to, a CDMA receiver must further distinguish between the various channels originating from that transmitter. For example, a BTS will transmit unique channels to many mobile users, and each UE receiver must distinguish each of its own channels from all the other channels transmitted by the BTS. In W-CDMA, this function is provided by the channelization codes, also known as OVSF codes.

Each channel originating from a W-CDMA BTS or UE is multiplied by a different orthogonal code (OVSF code<sup>2</sup>). In W-CDMA, the length of these codes, also known as the spreading factor (SF), can be configured from 4 to 512 chips, with the resulting downlink (DL) symbol rate being equal to the system chip rate of 3.84 Mcps divided by the SF. For example, a SF of four corresponds to a symbol rate of 960 kspcs.

The entire set of OVSF codes is identical for each UE and BTS. The scrambling code allows OVSF code reuse among UE and BTS within the same geographic location. Therefore, it is the combination of OVSF and scrambling codes that provides a unique communication channel between a UE and BTS.

The W-CDMA radio link between the BTS and UE must support multiple simultaneous data channels. For example, a 3G connection may include bi-directional voice, video, packet data, and background signaling messages, each representing a unique data channel within a single frequency carrier.

---

1. The W-CDMA specifications use the term UE to refer to mobile phones, wireless computing devices, or other devices that provide wireless access to the W-CDMA system.  
2. The synchronization channels are an exception to this, as described later.

Figure 2 illustrates a W-CDMA system with two BTSs and four UEs. The scrambling code (SC) provides a unique identity to each UE and each BTS. The OVSF code allocations provide a unique identity to each channel conveyed by a UE or BTS within one cell. For example, SC<sub>2</sub> identifies BTS 2, and SC<sub>6</sub> identifies UE 4. BTS 2 uses OVSF<sub>4</sub> and OVSF<sub>5</sub> to send voice and signaling information to UE 4. This UE uses OVSF<sub>1</sub> and OVSF<sub>2</sub> to send voice and signaling information back to BTS 2. Note that other BTS and UE also use the same OVSF codes (OVSF<sub>1</sub> and OVSF<sub>2</sub>). This is not a problem since the scrambling codes decorrelate the re-used OVSF codes.

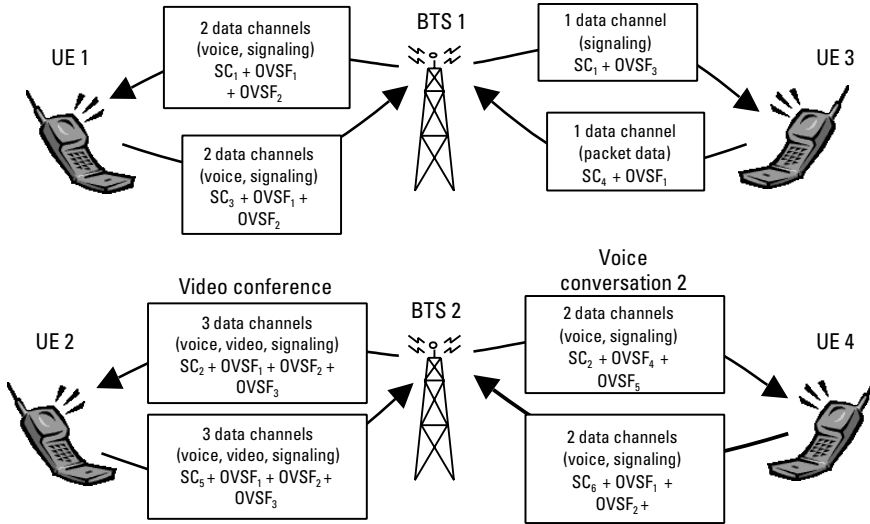

**Figure 2. W-CDMA code allocations**

The combination of OVSF codes and scrambling codes provide the signal spreading, and therefore, the spreading gain needed for the receiver correlators to pull the desired signal out of the noise. The SF determines the degree of spreading gain. For high data-rate signals, the SF and spreading gain are lower. For the same level of interference, the amplitude for high data-rate channels must be higher in order for all channels to maintain equal energy-per-bit-to-noise ratio ( $E_b/N_o$ ).

SFs may be reassigned as often as every 10 msec. This allows the W-CDMA network to dynamically reassign bandwidth that would otherwise be wasted.

## 1.4 Slots, frames, and power controls

All W-CDMA uplink (UL) and DL data channels are segmented into time slots and frames. A slot is 666.667  $\mu\text{sec}$  in length, equal in duration to 2560 chips of the system chip rate. Fifteen of these time slots are concatenated to form a 10 ms frame (Figure 3). The frame is the fundamental unit of time associated with channel coding and interleaving processes. However, certain time-critical information, such as power control bits, are transmitted in every time slot. This facilitates UE power control updates at a rate of 1500 adjustments per second to optimize cell capacity.

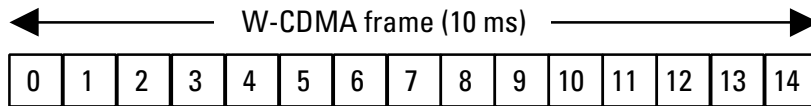

Figure 3. W-CDMA slot and frame structure

In any cellular CDMA system, the BTS must precisely control the transmit power of the UEs at a rate sufficient to optimize the link budget. This is referred to as UL power control. The goal is to balance the power received at the BTS from all UEs within a few dB, which is essential to optimizing the UL spread spectrum link budget. The UE also sends power control bits to the BTS at the same rate, and the BTS responds by adjusting the power of the data channels that are intended for the respective UE. This is referred to as DL power control.

## 1.5 Protocol structure

The protocol structure of the W-CDMA system closely follows the industry standard Open System Interconnection (OSI) model. Figure 4 shows the three bottom layers.

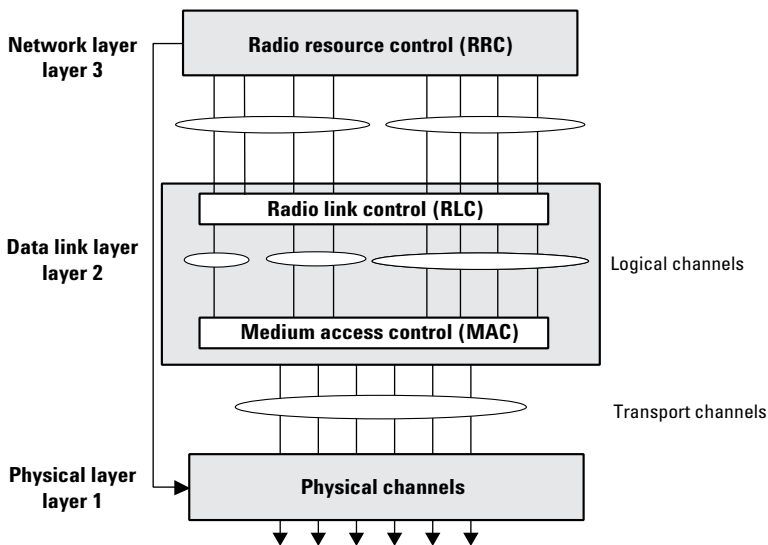

Figure 4. W-CDMA protocol structure

The network layer (layer 3) is based heavily on GSM standards. It is responsible for connecting services from the network to UE. The data link layer (layer 2) is composed of two main functional blocks: the radio link control (RLC) and medium access control (MAC) blocks. The RLC block is responsible for the transfer of user data, error correction, flow control, protocol error detection and recovery, and ciphering. The MAC function at layer 2 is responsible for mapping between logical channels and transport channels (see following section) as well as providing the multiplexing/de-multiplexing function of various logical channels efficiently onto the same transport channel. The physical layer (layer 1) maps the transport channels on to the physical channels and performs all of the RF functions necessary to make the system work. These func-

tions include operations such as frequency and time synchronization, rate matching, spreading and modulation, power control, and soft handoff. This application note focuses on layer 1 and refers to layer 2 briefly when appropriate. For more information on layer 2 and above, refer to the 3GPP specifications documents available on their web site ([www.3gpp.org/specifications](http://www.3gpp.org/specifications)).

## 1.6 Logical, transport, and physical channels

Logical channels are the information content, which will ultimately be transmitted over the physical channels. Logical channels include the Broadcast Control Channel (BCCH), the Paging Control Channel (PCCH), the Common Control Channel (CCCH), and Dedicated Control and Traffic Channels (DCCH, DTCH).

W-CDMA introduces the concept of transport channels to support sharing physical resources between multiple services. Each service, such as data, fax, voice, or signaling is routed into different transport channels by the upper signaling layers. These services may have different data-rates and error control mechanisms. The transport channels are then multiplexed as required prior to transmission via one or more physical channels. High data-rate services or a combination of lower-rate transport channels may be multiplexed into several physical channels. This flexibility allows numerous transport channels (services) of varying data rates to be efficiently allocated to physical channels. By multiplexing these transport channels efficiently, system capacity is optimized. For example, if the aggregate data rate of three transport channels exceeds the maximum of a single physical channel, then the data can be routed to two lower rate physical channels that closely match the total required data rate. Transport channels include the Broadcast Channel (BCH), the Paging Channel (PCH), the Forward Access Channel (FACH), the Dedicated Channel (DCH) and the Random Access Channel (RACH).

The W-CDMA DL is composed of a number of physical channels. The most important DL physical channels are the Common Pilot Channel (CPICH), the Primary Common Control Physical Channel (P-CCPCH), the Secondary Common Control Physical Channel (S-CCPCH), and the Dedicated Physical Data and Control Channels (DPDCH/DPCCH). The UL consists of a Physical Random Access Channel (PRACH), a Physical Common Packet Channel (PCPCH), and Dedicated Physical Data and Control Channels (DPDCH/DPCCH). These channels are described in the following sections.

Figure 5 shows an example of channel mapping for the DL. When a UE is in the idle mode, the BTS sends dedicated signaling information from the DCCH logical channel through the FACH transport channel. This maps the information onto the S-CCPCH physical channel for transmission to a UE. When the UE is in the dedicated connection mode, the same signaling information is routed through the DCH transport channel. This maps the information onto the DPDCH/DPCCH physical channel for transmission to the UE.



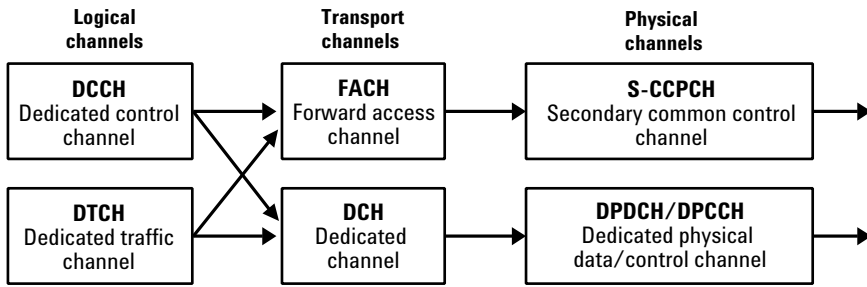

Figure 5. Example of logical, transport, and physical channel mapping (DL)

## 1.7 Downlink physical channels

Figure 6 shows the slot and frame structure for the CPICH, P-CCPCH, and SCH.

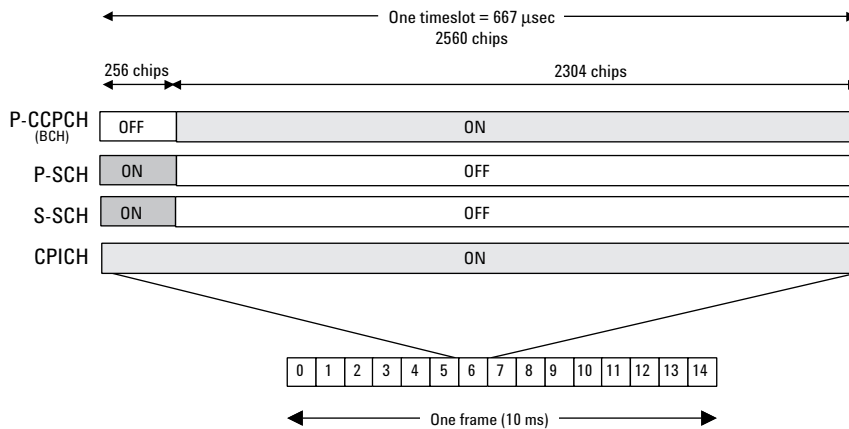

Figure 6. CPICH, P-CCPCH and SCH slot and frame structure

The CPICH is a continuous loop broadcast of the BTS scrambling code. As described earlier, the scrambling code provides identification of the BTS transmission. The UE uses the CPICH as a coherent reference for precise measurement of the BTS time reference, as well as to determine the signal strength of surrounding BTS before and during cell site handover. Since no additional spreading is applied to this signal, it is quite easy for the UE to acquire a lock to this reference. This must occur before any other channels can be received.

The P-CCPCH is time multiplexed with an important channel used by the UE during system acquisition, the Synchronization Channel (SCH). This carries two sub-channels, the Primary Synchronization Channel (P-SCH) and Secondary Synchronization Channel (S-SCH). These channels consist of two codes known as Primary Synchronization Code (PSC) and Secondary Synchronization Code (SSC). The PSC is a fixed 256-chip code broadcast by all W-CDMA BTSs. During initial acquisition, the UE uses the PSC to determine if a W-CDMA BTS is present and establish the slot boundary timing of the BTS. The SSC represents a group, called a code group, of 16 subcodes, each with a length of 256 chips. The BTS transmits these codes in an established order, one SSC subcode in each time slot of a frame. When a UE decodes 15 consecutive SSC transmissions, it can determine the BTS frame boundary timing, as well as derive information that will aid in the identification of the BTS scrambling code (see section 1.14).

The SCH is transmitted during the first 256 chips of each time slot while the P-CCPCH is off (Figure 6). During the remaining 2304 chips of each slot the P-CCPCH, which contains 18 bits of broadcast data (Broadcast Channel (BCH) information) at a rate of 15 kbps, is transmitted. Since the cell's broadcast parameters message will require more than 18 bits, the broadcast information may span several frames.

The Dedicated Physical Channel (DPCH) carries all the user data and user signaling, as well as physical channel control bits for the slot format and the UE inner loop power control. The DPCH consists of the DPDCH and the DPCCH (Figure 7). The user's digitized voice and/or digital data, along with layer 3 signaling data, are carried on the DPDCH. The user data and signaling data are individually treated with error protection coding and interleaving, then multiplexed together to form the DPDCH. The DPDCH is then multiplexed with the DPCCH, which contains the Transmit Power Control (TPC) bits (to control the UE transmit power), Transport Format Combination Indicator (TFCI) bits (indicates the slot format and data rate), and embedded Pilot bits (short synchronization patterns embedded within each slot).

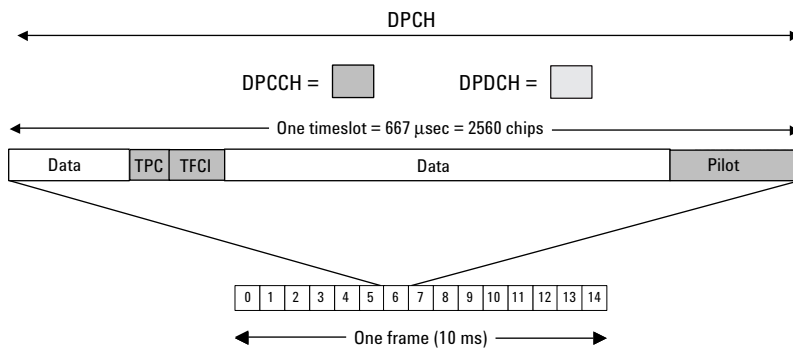

**Figure 7. DPCH (DPDCH/DPCCH) slot and frame structure**

Other DL channels include the Secondary Common Control Physical Channel (S-CCPCH), used to transmit pages and signaling to idling UEs; the Acquisition Indication Channel (AICH), used to acknowledge UE access requests; a Paging Indication Channel (PICH), used to alert the UE of a forthcoming page message; a Physical Downlink Shared Channel (PDSCH), used to dish out packet data to a number of UEs; and additional DPDCHs to increase DL data throughput for a single UE. Release 7 specifies additional channels for HSPA, with designation beginning High Speed (eg. HS-xxxx). These have the same function as in earlier releases, but with enhanced physical implementation.

## 1.8 Uplink physical channels

The PRACH carries the RACH transport channel, which is used by the UE to request connection to the network as well as for intermittent services such as low duty cycle packet data. PRACH transmissions begin with a short preamble pattern that alerts the BTS of the forthcoming PRACH access message. The preamble consists of a complex signature and a scrambling code. The signature is a series of 16 bits that is repeated 256 times within a single preamble. All BTS use the same 16 signatures. The BTS tells each UE which signature to use and then uses the signature to determine which UE it is communicating with. The scrambling code is used by the BTS to determine that the PRACH transmission is intended for that BTS. It can also allow the BTS to determine the access class of the UE. Access class is a means of establishing priority of access for different UE or different service types. In general, the preamble transmission can be initiated at any random instant and is therefore subject to collisions with other users. In this case, the UE will retransmit the preamble using different time access slots until acknowledgment is received.

The message part is transmitted as part of the PRACH after the UE receives acknowledgment from the BTS on the DL AICH. It consists of two parts: a control part and a data part. These two parts are transmitted in parallel. Figure 8 shows the message part structure. The control part carries the pilot and TFCI bits. The data part consists only of data bits that contain the information the UE wants to send to the network. The message part uses the same scrambling code used in the preamble.

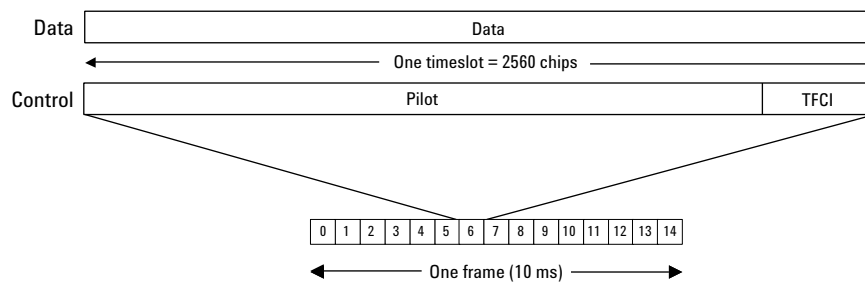

Figure 8. Structure of the message part in the PRACH

The UL DPDCH/DPCCH carries the user's digitized voice and data channels along with layer 3 signaling data. The payload data and signaling data (DPDCH) are transmitted on the "I" path of the QPSK modulator; the power control, pilot, and other overhead bits (DPCCH) are transmitted on the "Q" path. Figure 9 shows the slot structure of a DPDCH and a DPCCH. Multiple DPDCHs may be transmitted. In this case they are consecutively assigned to either the I or Q paths. Each channel is spread by an OVSF code and its amplitude can be individually adjusted. Before modulation, the composite spread signal is scrambled with a special function that minimizes the signal transitions across the origin of the I/Q plane and the 0° phase shift transitions. This improves the peak-to-average power ratio of the signal.

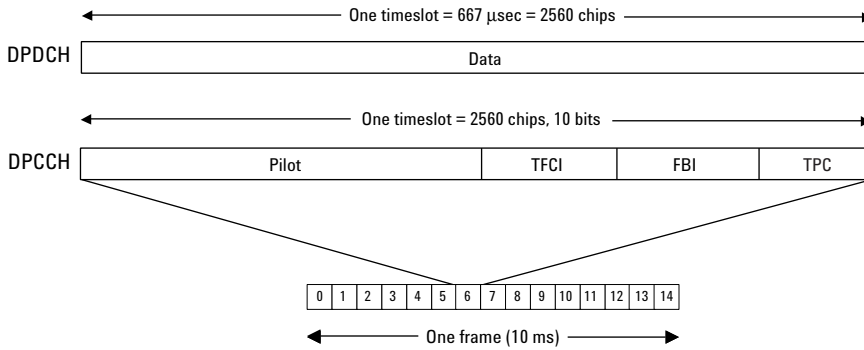

Figure 9. Uplink slot structure of a DPDCH and a DPCCH

Later revisions of the standards specify additional physical and logical channels for High Speed Packet Access (HSPA, comprising High Speed Downlink Packet Access (HSDPA) and High Speed Uplink Packet Access (HSUPA)). The downlink channels are all prefixed "HS-", and uplink channels by "E-" to distinguish them from standard W-CDMA.

Figure 9a illustrates the frame structure of the HS-DPCCH. The HS-DPCCH carries uplink feedback signalling related to downlink HS-DSCH transmission and to HS-SCCH orders. The feedback signalling consists of Hybrid-ARQ Acknowledgement (HARQ-ACK) and Channel-Quality Indication (CQI) and in case the UE is configured in Multiple Input Multiple Output (MIMO) mode of Precoding Control Indication (PCI) as well. Each sub frame of length 2 ms ( $3 \times 2560$  chips) consists of 3 slots, each of length 2560 chips. The HARQ-ACK is carried in the first slot of the HS-DPCCH sub-frame. The CQI, and in case the UE is configured in MIMO mode also the PCI, are carried in the second and third slot of a HS-DPCCH sub-frame. There is at most one HS-DPCCH on each radio link. The HS-DPCCH can only exist together with an uplink DPCCH.

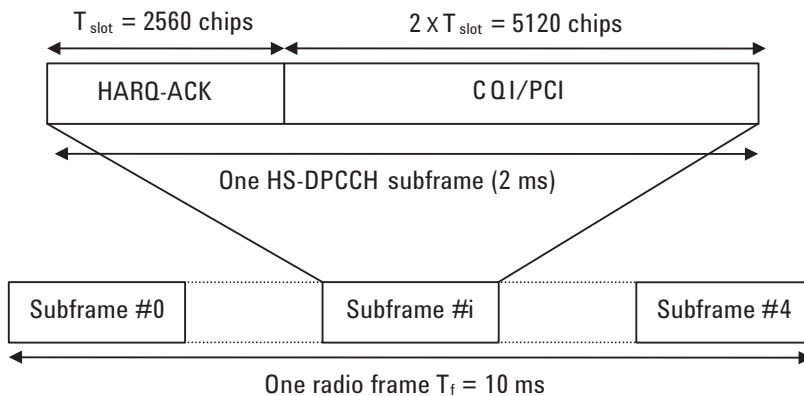

Figure 9a. Frame structure for uplink HS-DPCCH

The E-DPDCH is used to carry the E-DCH transport channel. There may be zero, one, or several E-DPDCH on each radio link.

The E-DPCCH is a physical channel used to transmit control information associated with the E-DCH. There is at most one E-DPCCH on each radio link.

E-DPDCH and E-DPCCH are always transmitted simultaneously, except for the following cases when E-DPCCH is transmitted without E-DPDCH:

- when E-DPDCH but not E-DPCCH is DTXed due to power scaling or
- during the  $n_{dtx}$  E-DPDCH idle slots if  $n_{max} > n_{tx1}$

E-DPCCH shall not be transmitted in a slot unless DPCCH is also transmitted in the same slot.

Figure 9b shows the E-DPDCH and E-DPCCH (sub)frame structure. Each radio frame is divided in 5 subframes, each of length 2 ms; the first subframe starts at the start of each radio frame and the 5<sup>th</sup> subframe ends at the end of each radio frame.

An E-DPDCH may use BPSK or 4PAM (4-state pulse amplitude modulation) symbols. In Figure 9b, M is the number of bits per modulation symbol i.e. M = 1 for BPSK and M = 2 for 4PAM.

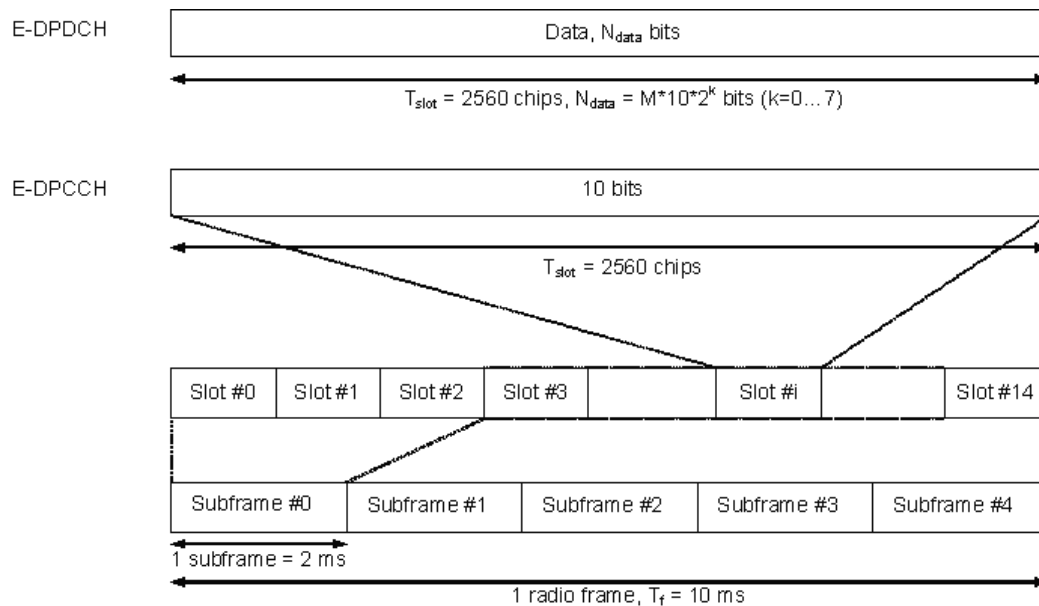

Figure 9b. E-DPDCH frame structure

## 1.9 Transport format detection

The number of possible arrangements of the W-CDMA air interface numbers in the millions. For any given connection only a small subset of these are needed. To make operation practical, that subset, known as the Transport Format Combination Set (TFCS), is communicated from the network to the UE at the time of connection setup. The TFCS includes all of the allowable Transport Formats (TF) and the associated data capacity for each of the channels that can be present in the link, and all of the allowable Transport Format Combinations (TFC) for the link. The Network's Radio Resource Control (RRC) entity provides this information to its lower layers. The UE's RRC entity does the same for its lower layers upon receiving the TFCS from the network.

Once this information is shared between the two, the transmitter can use it, along with the demands for transmission capacity from higher layers, to decide which channels shall be present and how each channel will be arranged in the radio frame. Likewise the receiver can use it to determine which channels are present and how to recover each channel that is present.

The W-CDMA system provides two methods to make this determination. The first of these is the inclusion of a Transport Format Combination Indicator (TFCI) in each radio frame. The second is Blind Transport Format Detection (BTFD).

When TFCI is used, the transmitting side determines which Transport Format Combination it will use. It then includes the TFCI, which is an index to the list of allowable combinations in the TFCS, in the control portion of the DPCH. The receiver always knows how to recover the TFCI, which it then uses to determine which channels to try to recover and how to decode each one.

When BTFD is used, the receiver must try every allowable TFC in the TFCS to determine which one results in the least errors.

## 1.10 Downlink DPDCH/DPCCH coding and air interface

Figure 10 shows an example of the coding, spreading, and scrambling for the DPCH. In this example, a 12.2 kbps voice service is carried on a DTCH logical channel that uses 20 ms frames. After channel coding, the DTCH is coded with a 1/3 rate convolutional encoder. In this example, the data is then punctured (rate matching) and interleaved. At this point, the DTCH is segmented into 10 ms frames to match the physical channel frame rate. The DCCH logical channel carries a 2.5 kbps data stream on a 40 ms frame structure. The DCCH is coded in the same manner as the DTCH. Frame segmentation for the DCCH involves splitting the data into four 10 ms segments to match the physical channel frame rate. The DTCH and DCCH are multiplexed together to form the Coded Composite Transport Channel (CCTrCH). The CCTrCH is interleaved and mapped onto a DPDCH running at 42 kbps.

In this example, the DPCCH is running at a rate of 18 kbps. The DPDCH and DPCCH are time multiplexed together to form a 60 kbps stream (DPCH). This stream is converted into separate I and Q channels with a symbol rate of 30 ksps for each channel. The DPCH is spread with an OVSF code with spread factor equal to 128 (to reach the desired 3.84 Mcps), which differentiates the signal from others within the cell or sector. After that process, it is complex scrambled with a code that identifies each cell or sector. The resulting I and Q signals are then filtered and used to modulate the RF carrier (not shown in the figure).

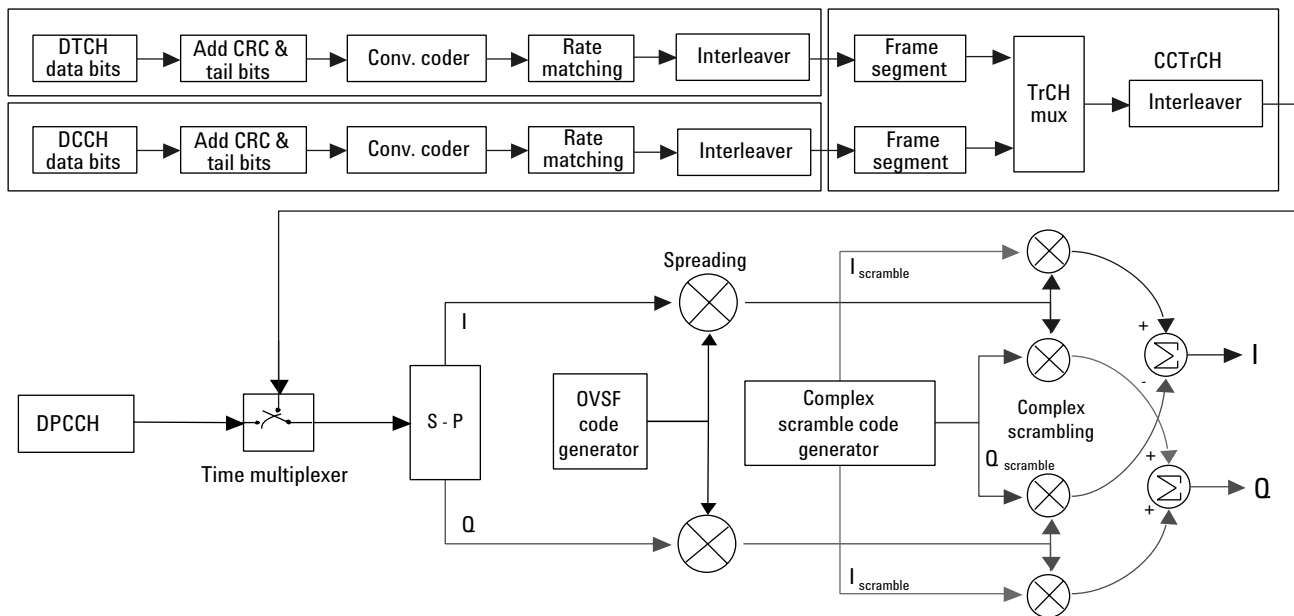

Figure 10. Downlink DPDCH/DPCCH coding, spreading, and scrambling.

## 1.11 Uplink DPDCH/DPCCH coding and air interface

The spreading and scrambling used on the UL DPDCH/DPCCH differs from the DL in two key areas: I/Q multiplexing and hybrid phase shift keying (HPSK) scrambling instead of complex scrambling). Figure 11 shows an example of the coding and air interface for a DPCCH interface for a UL DPDCH and a DPCCH. In this example, the logical DTCH carries a 12.2 kbps voice channel and the logical DCCH carries a 2.5 kbps signaling channel. Each of these logical channels is channel coded, convolutionally coded, and interleaved. The DTCH uses 20 ms frames. At the frame segmentation point, the DTCH is split into two parts to conform with the physical layer's 10 ms frame structure. The DCCH, which operates with 40 ms frames, is split into four parts so that each signaling frame is spread over four 10 ms radio frames. These channels are then punctured (rate matching) and multiplexed prior to spreading. The multiplexed data at this point is called the Coded Composite Transport Channel (CCTrCH). After a second interleaving, the CCTrCH is mapped onto a DPDCH running at 60 kbps. The DPDCH is spread with an OVSF code with spread factor equal to 64 in order to reach the desired 3.84 Mcps. After gain scaling (to adjust the transmission power for the variable spreading factor), the spread DPDCH is applied to the I channel.

The data rate for the UL DPCCH is always 15 kbps. The DPCCH data is spread with an OVSF code with  $SF = 256$  to reach the 3.84 Mcps rate and is gain scaled in this example to be  $-6$  dB relative to the DPDCH. The DPCCH is then applied to the Q channel.

If additional DPDCHs were present they would be assigned to I or Q and spread with the appropriate OVSF code. Before modulation, the composite spread signal is scrambled with a special complex function that limits the signal transitions across the origin of the I/Q plane and the  $0^\circ$  phase shift transitions. This improves its peak-to-average power ratio. This function can be considered a variation of regular complex scrambling and is commonly known as HPSK, although this term is not mentioned in the 3GPP specifications. The scrambling generator produces two random sequences (referenced in the 3GPP specifications as  $C_{long,1}$  and  $C_{long,2}$ , if long scrambling sequences are used).

The second sequence is decimated, multiplied by the function  $\{1,-1\}$  and by the first sequence, and applied to the Q path of the complex scrambler. The first sequence is applied to the I path of the complex scrambler.



The resulting I and Q signals are then filtered with an RRC filter ( $\alpha = 0.22$ ) and used to modulate the RF carrier (not shown in the figure).

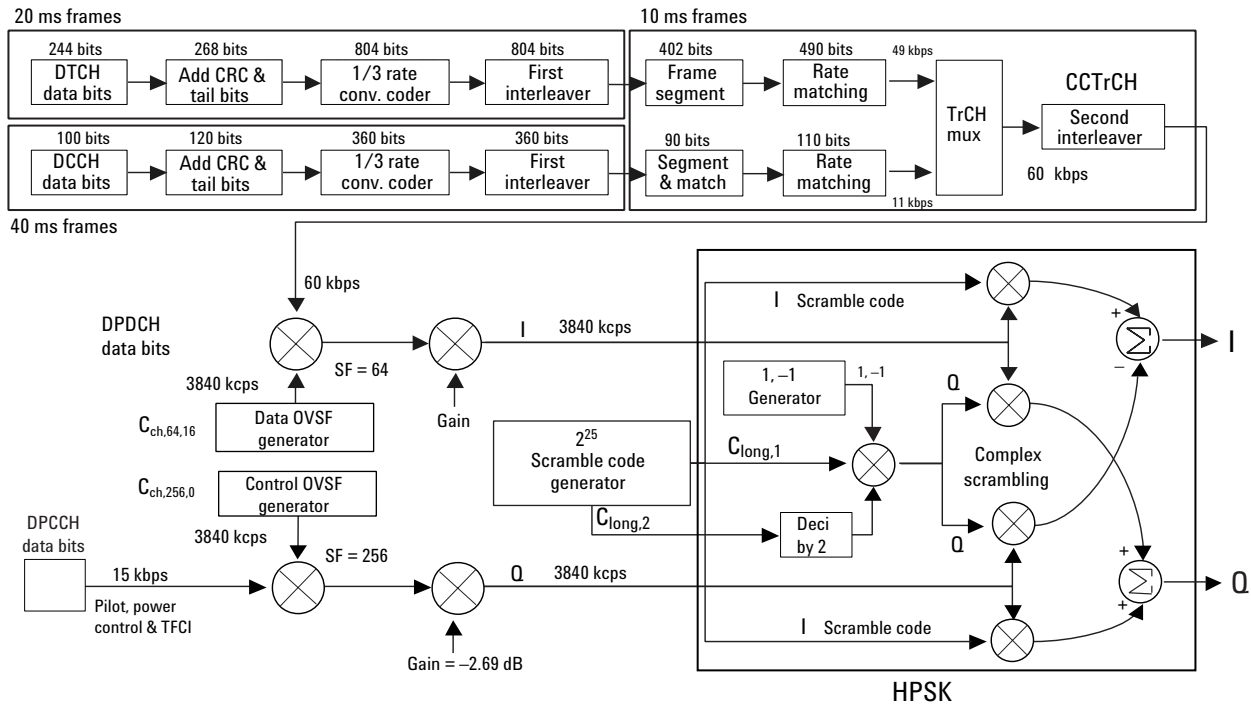

Figure 11. Uplink DPCH/DPCCH coding, spreading, and scrambling.

## 1.12 Test models and reference measurement channels

In order to avoid ambiguity and inconsistency across different equipment suppliers, the 3GPP specifications define the DL and UL channel configurations to use for BTS transmitter and receiver conformance testing, respectively.

The DL test configurations are called test models. There are four test models in Release 99 and Release 4. An additional test model (Test Model 5) for BTSs that support High Speed Downlink Packet Access (HSDPA) has been added in Release 5 and a further test model (6) has been added in Release 7 for testing relative code domain error (RCDE) in equipment that supports 64QAM HS-PDSCH transmission. Each transmitter conformance test requires the BTS to transmit one of these models. For example, test model 2 is used for the output power dynamics and the CPICH power accuracy tests.

The UL test configurations are called reference measurement channels (RMC) and Fixed Reference Channels (FRC). There are six UL reference measurement channels including the RACH and HS-DPCCH and eight UL Fixed Reference Channels. The main difference between them is the information bit rate for the DTCH logical channel (12.2 kbps, 64 kbps, 144 kbps, 384 kbps, or 2048 kbps). Most of the reference measurement channels consist of a DPCCH and a DPDCH.

The data rates in the channel configuration example in Figure 11 correspond to the 12.2 kbps UL reference measurement channel. This is the reference measurement channel specified by the standard for most BTS receiver conformance tests. All receiver characteristics tests specify RMC 12.2 kbps and it is commonly used in production for Rx sensitivity and functional verification.

## 1.13 Fixed reference measurement channels

There are eight UL fixed reference channels. Fixed reference channels are used to support High Speed Uplink Packet Access (HSUPA) Rx performance tests (3GPP TS 25.141 v8.6.0). Performance requirements are specified for a number of test environments and multi-path channel classes (3GPP TS 25.141). The requirements only apply to those reference measurement channels that are supported by the base station. The key performance metric for HSUPA is demodulation of the E-DPDCH in multipath fading conditions. The performance requirement of the E-DPDCH in multipath fading conditions is determined by the minimum throughput, R, which is defined as the sum (in kilobits) of the information bit payloads (excluding the 24-bit CRC) successfully received during the test interval, divided by the duration of the test interval (in seconds). The throughput value R can be mapped unambiguously to a BLER metric.

## 1.14 Compressed mode

Compressed mode allows the BTS and UE to momentarily stop transmitting a particular DPCH. This enables the UE to make signal strength measurements on other frequencies, as would be needed to perform an inter-frequency or inter-system (hard) handover. One to seven slots per frame can be allocated for the UE to perform these measurements. These slots can be in the middle of a single frame or spread over two frames. The portions of the frame where the power is turned off are referred to as Discontinuous Transmission (DTX).

The 3GPP specifications define three different methods to achieve compressed mode:

- Reducing the SF by 2 (shorter OVSF code). The data is transmitted at a higher rate to make room for DTX.
- Reducing the symbol rate by puncturing the output of the error correction encoder to reduce the number of bits per frame to a number that can be carried by the smaller number of symbols available in the compressed radio frame.
- Higher layer scheduling. The data rate from higher layers in the protocol is limited by restricting the TFCs that can be used and delaying the transmission of some data. This effectively reduces the number of timeslots for user traffic.

## 1.15 Asynchronous cell site acquisition

One of the W-CDMA design goals was to remove the requirement for GPS synchronization. Without dependence on GPS, the system could potentially be deployed in locations where GPS is not readily available, such as in a basement of a building or in temporary locations. W-CDMA accomplishes this asynchronous cell site operation through the use of several techniques.

First, the scrambling codes in W-CDMA are Gold codes, so precise cell site time synchronization is not required. There are, however, 512 unique Gold codes allocated for cell site separation that the UE must search through. To facilitate this task, the SSC in the S-SCH channel is used to instruct the UE to search through a given set of 64 Gold codes. Each set represents a group of eight scrambling codes ( $64 \times 8 = 512$ ). The UE then tries each of the eight codes within each code group, in an attempt to decode the BCH. The ability to recover the BCH information (system frame number) completes the synchronization process.

## 1.16 Asynchronous cell site soft handover

In W-CDMA soft handover, a UE can establish simultaneous communication with several BTSs. During soft handover the combined signals from each BTS are individually correlated and then combined. As such, communication is possible in situations where an individual signal from a single BTS might otherwise be too weak to support the radio link.

Because each W-CDMA BTS operates on an asynchronous clock, soft handover is complicated by the fact that frame timing between BTSs is not explicitly coordinated. The UE could therefore have a difficult time combining frames from different BTSs. To get around this problem, the W-CDMA UE measures the frame timing differential between the originating BTS and the handover target BTS. The UE reports this frame timing back to the network, which then issues a frame timing adjustment command to the target BTS. The target BTS adjusts the frame timing of the DPDCH/DPCCH channel that is being transmitted so the UE receives the target BTS frames in close time alignment with the corresponding frames from the originating BTS. With this time alignment feature, UE's rake receiver is able to track the received signals from both BTSs.

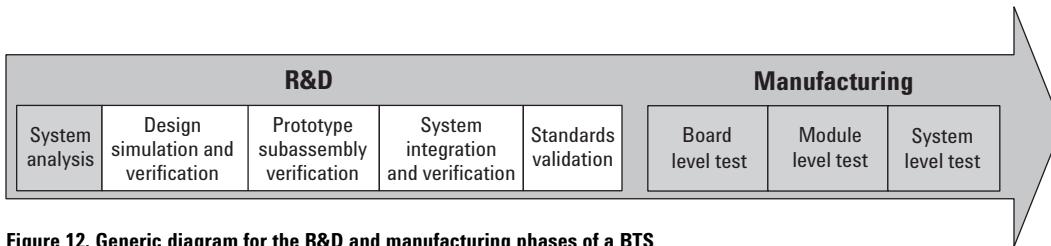

Figure 12. Generic diagram for the R&D and manufacturing phases of a BTS

## 2. General Design and Measurement Issues

Figure 12 shows a generic diagram for the R&D and manufacturing phases of a BTS. This chapter focuses on the development phase of the BTS (highlighted in white), however, it contains general information that may be useful to engineers involved in any area of the BTS life cycle.

### 2.1 Controlling interference

In CDMA systems, each active user communicates at the same time, on the same frequency. Because each user uses a different spreading code, they look like random interference to each other. The capacity of the system is ultimately determined by the minimum operating signal to interference ratio (SIR) of the receiver. However, whatever the budget is, the number of users that can coexist in one frequency channel depends on the level of interference generated by each user. This is a statistical quantity that depends on many factors, ranging from network topology down to how a user holds his or her phone. As a result, system design has proven to be heavily dependent on detailed simulations.

Two important performance factors that can be specified, measured, and controlled are adjacent channel interference and average power. Power leakage from adjacent channels contributes to the noise floor of the channel. It directly reduces the available margin and hence system capacity. Fast and accurate power control is also critical to the performance of a CDMA system because a user transmitting at higher power than is necessary to achieve a satisfactory error rate, even for a short time, reduces system capacity.

The following sections describe some of the key tests to characterize these RF power performance factors.

### *2.1.1 Average RF power*

Average RF power will probably remain the preferred measurement for manufacturing testing, even for sophisticated modulation schemes such as CDMA; but for any modulated signal, average RF power is only part of the picture. In the research and development phase, engineers are interested in peak power, peak to average power ratio (PAR), and, particularly for CDMA, power statistics such as the complementary cumulative distribution function (CCDF) – described later in the chapter.

The preferred solution is to measure average power using a signal analyzer with a channel power measurement. Care must be taken to ensure that the amplitude accuracy of the instrument meets the needs of the measurement specifications. For some analyzers, the absolute amplitude accuracy is as low as 0.6 dB (similar to a power meter's accuracy.) For others, the accuracy can be more than  $\pm 1$  dB, though the relative accuracy is usually much better than  $\pm 1$  dB. An advantage of using a signal analyzer is that it provides a larger suite of required measurements, including modulation quality analysis.

The specifications for 6.2.1 BTS maximum output power in define the output power as the mean power level per carrier measured at the antenna connector.

### 2.1.2 Adjacent channel interference

Depending on the context, the acronym ACP(R) has been taken to mean either adjacent channel power (ratio), which is a transmitter measurement, or adjacent channel protection (ratio), which is a receiver measurement. To resolve this ambiguity, 3GPP has introduced three new terms: adjacent channel leakage power ratio (ACLR), adjacent channel selectivity (ACS), and adjacent channel interference ratio (ACIR).

ACLR is a measure of transmitter performance. It is defined as the ratio of the transmitted power to the power measured after a receiver filter in the adjacent RF channel. This is what was formerly called adjacent channel power ratio.

ACS is a measure of receiver performance. It is defined as the ratio of the receiver filter attenuation on the assigned channel frequency to the receiver filter attenuation on the adjacent channel frequency.

ACIR is a measure of overall system performance. It is defined as the ratio of the total power transmitted from a source (BTS or UE) to the total interference power resulting from both transmitter and receiver imperfections affecting a victim receiver. ACIR is mainly of interest in network simulation where the total amount of interference, rather than the source of the interference, is the primary concern. This is what was formerly called adjacent channel protection ratio.

The following equation shows the relationship between ACIR, ACLR, and ACS:

$$\text{ACIR} = \frac{1}{\frac{1}{\text{ACLR}} + \frac{1}{\text{ACS}}}$$

The main source of adjacent channel leakage (ACL) is non-linear effects in the power amplifiers (PA). ACL directly affects the co-existing performance of systems on adjacent channels. Power leakage is a general noise pollution and degrades performance of the system in the adjacent channel. If sufficiently bad, it can cause the so called “near-far” problem, where a BTS simply cannot communicate with a far away UE because of high ACL from a nearby adjacent channel BTS. Network planning can address this problem, but the associated costs depend directly on the stringency of the ACLR specification. So, we have conflicting needs. From an equipment design perspective a relaxed ACLR specification is attractive, whereas from a network planning perspective, low ACL is very desirable.

There has been much discussion of this within the specifications committees. The current values in the 3GPP specifications for the BTS are 45 dB at 5 MHz offset and 50 dB at 10 MHz offset.

ACLR (or ACPR) is commonly measured using a signal analyzer or measuring receiver. In the measurement, filtering is applied to both the power in the main frequency channel and the power in the adjacent channel. An important factor for ACLR is the specification of the measurement filter, including its bandwidth and shape. Original W-CDMA specifications called for a rectangular filter, but this has now changed to a RRC filter with a  $-3$  dB bandwidth equal to the chip rate. This provides a closer indication to real-life performance. However, it requires the measuring instrument to apply precise filter weighting. This may preclude making the measurement with existing spectrum analyzers that do not have particular W-CDMA ACLR capability, although in reality, the difference in the measurement result is very small (around 0.1 dB). Figure 13 shows an ACLR measurement for a W-CDMA DL signal configured as test model 1 with 16 DPCHs. The measurement was performed using a vector signal analyzer with the appropriate RRC filter, as specified.

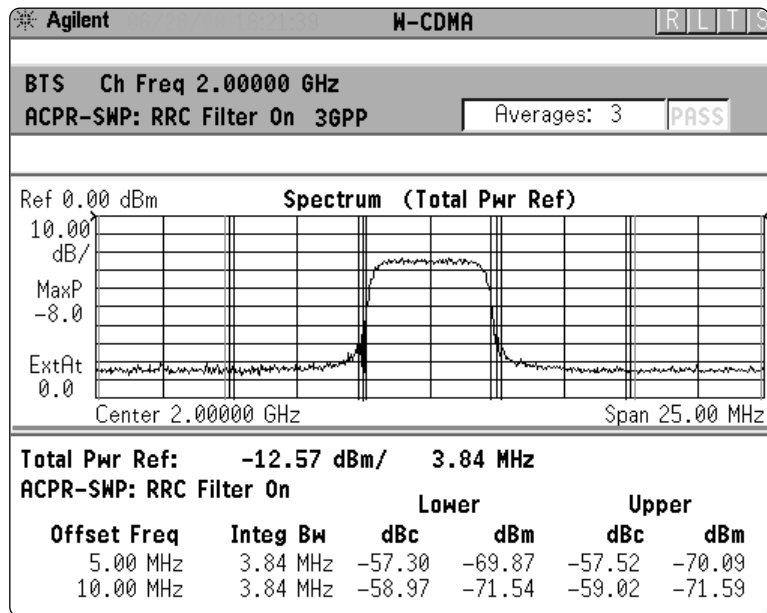

Figure 13. ACLR measurement for test model 1 with 16 DPCHs.

## 2.2 Handling high peak-to-average power ratios (PAR)

ACLR is a key parameter, but why is it a particular challenge to maintain good ACLR performance for a W-CDMA BTS?

Some of the 2G systems, such as GSM, use a constant modulation format (Gaussian minimum shift keying (GMSK)). GSM has the advantage of having a constant amplitude envelope, which allows the use of less expensive, non-linear, class B PAs.

By contrast, CDMA systems use non-constant modulation formats. PAR is the ratio of the peak envelope power to the average envelope power of a signal. In general, low PARs are desirable, which reduce the required PA linear dynamic range.

In CDMA systems, multiple channels are added to modulate a single carrier. The PAR increases as code channels are activated. A PAR of 8 dB is not uncommon for a W-CDMA DL multi-channel signal. Amplifier design for W-CDMA BTS is particularly challenging because the amplifier must be capable of handling the high PAR the signal exhibits, while maintaining a good ACL performance. The use of multi-carrier power amplifiers pushes design complexity one step further.

Both the amplifier designer and the system integrator must make sure the PA (and other components) can handle the PAR for stressful channel configurations, while maintaining a good ACL performance. You can use the complementary cumulative distribution function (CCDF) to help you with this task.

### 2.2.1 Complementary cumulative distribution function

The CCDF fully characterizes the power statistics of a signal. It provides PAR versus probability. Figure 14 shows the CCDF curves for two W-CDMA DL signals with different channel configurations: a signal with one DPCH and a signal configured as test model 1 with 16 DPCHs. For a probability of 0.1 percent, the signal with 16 code channels has a higher peak-to-average ratio (8.5 dB) than the signal with one code channel (4.5 dB).

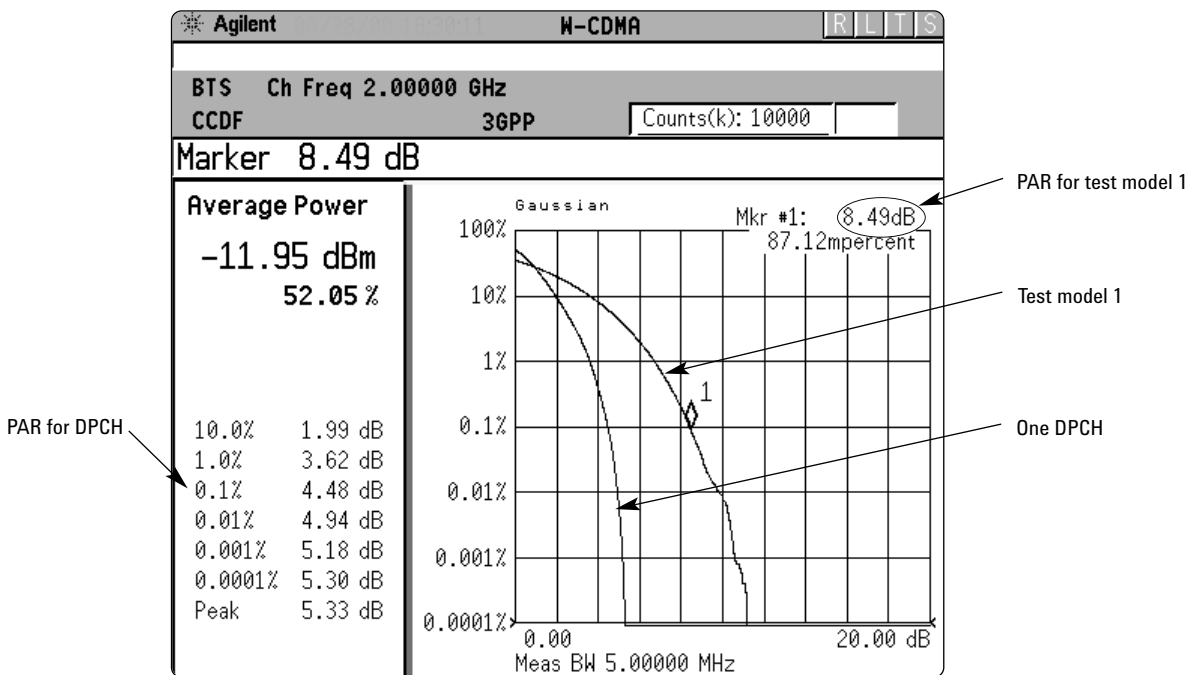

Figure 14. CCDF of a W-CDMA signal with one DPCH and a signal configured as test model one with 16 DPCHs



CCDF curves can help in several situations:

- to determine the headroom required when designing a component.
- to confirm the power statistics of a given signal or stimulus. CCDF curves allow you to verify if the stimulus signal provided by another design team is adequate. For example, RF designers can use CCDF curves to verify that the signal provided by the digital signal processing (DSP) section is realistic.
- to confirm that a component design is adequate or to troubleshoot your subsystem or system design. You can make CCDF measurements at several points in a system. For example, if the ACLR of a transmitter is too high, you can make CCDF measurements at the input and output of the PA. If the PA design is correct, the curves coincide. If the PA compresses the signal, the PAR of the signal is lower at the output of the PA (Figure 15).

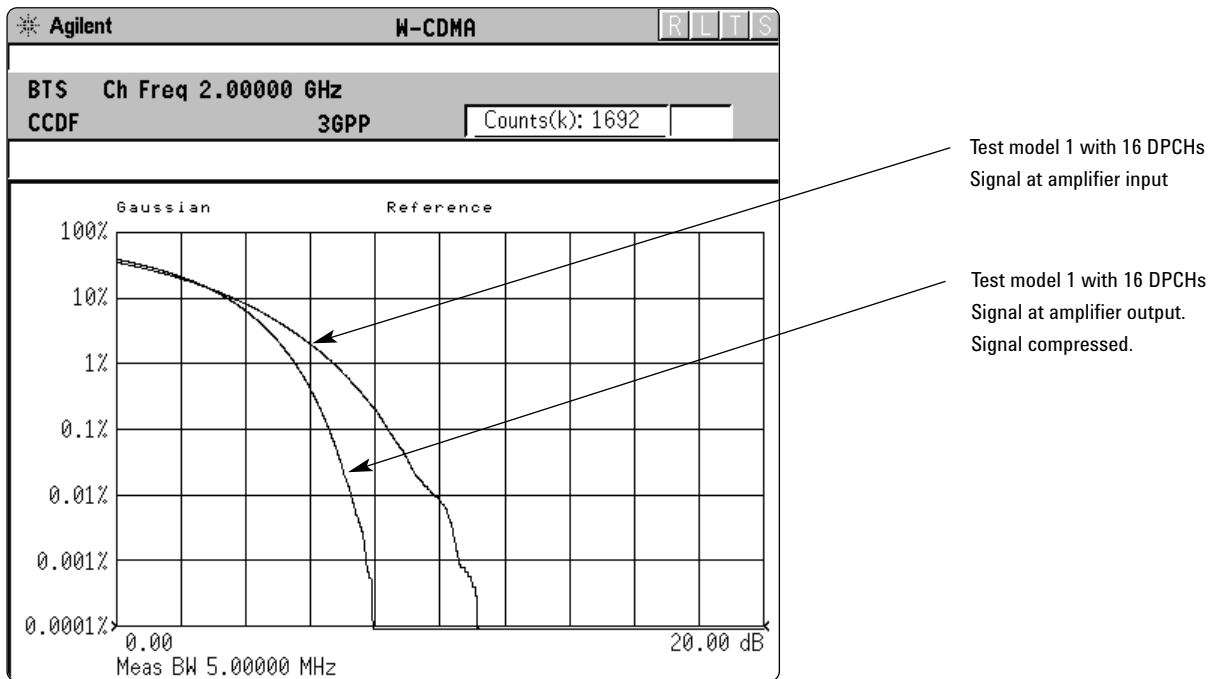

Figure 15. CCDFs for test model 1 with 16 code channels with and without compression

## 2.3 Measuring modulation accuracy

In constant amplitude modulation schemes, such as GMSK, the phase and the frequency error are the metrics for modulation quality. However, these metrics are not very effective for non-constant amplitude modulation formats, which can also have errors in amplitude.

The accuracy of non-constant amplitude modulation schemes, such as quadrature amplitude modulation (QAM), or quadrature phase shift keying (QPSK), can be assessed very effectively by looking at the constellation of the signal. Signal impairment can be objectively assessed by taking the displacement of each measured symbol from the reference position as an error phasor (or vector), as shown in Figure 16.

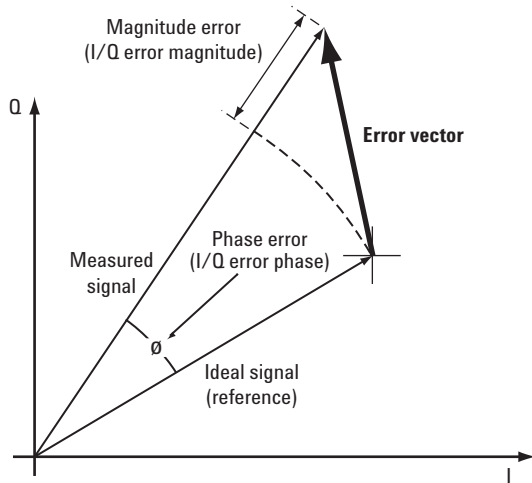

Figure 16. Error vector and related parameters

The reference position is determined from a reference signal that is synthesized by demodulating the data bits from the received signal and then re-modulating these bits “perfectly”, for a generic QPSK signal, as shown in Figure 17.

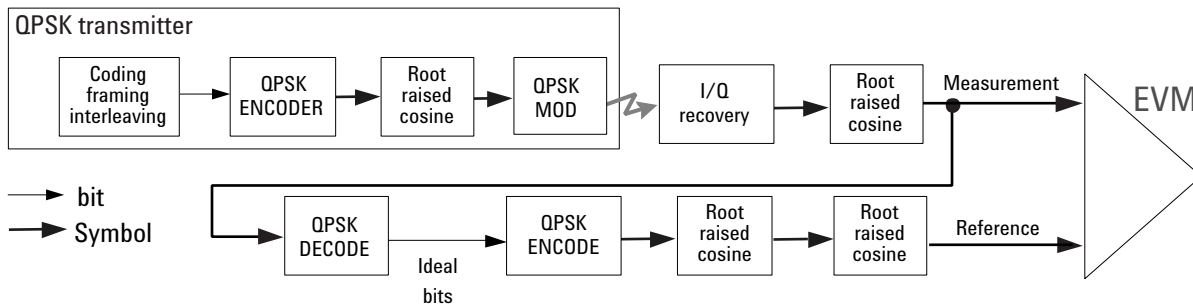

Figure 17. Process to calculate EVM for a generic QPSK signal

The root mean square (RMS) of the error vectors is computed and expressed as a percentage of the square root of the mean power of the ideal signal<sup>1</sup>. This is the error vector magnitude (EVM). EVM is a common modulation quality metric widely used in digital communication systems.

When we consider evaluating the modulation accuracy of W-CDMA it becomes evident that this explanation of EVM, while sufficient for ordinary QPSK or QAM, needs further elaboration. Shall we measure the EVM at the chip or at the symbol level? Shall we measure EVM for a signal with a single DPDCH channel or with another channel configuration? How do we calculate the reference?

1. The actual calculation method of the percentage depends on the specific standard. The EVM may be normalized to the amplitude of the outermost symbol, the square root of the average symbol power, or the square root of the mean power of the ideal signal. In the case of W-CDMA, the specifications require normalization to the square root of the mean power of the ideal signal (see section on Composite EVM).

The following sections explain the differences between the various EVM and other modulation quality measurements that you can perform on a W-CDMA DL signal and when they should be used.

### 2.3.1 QPSK EVM

For a QAM or a Phase Shift Keying (PSK) signal, the ideal symbol points always map onto a few specific locations in the I/Q plane. W-CDMA uses a QPSK format to modulate the spread signal (chips). However, the signal consists of several code channels. Each channel is QPSK encoded<sup>1</sup>, and the I and Q signals are spread and complex scrambled (see Figure 18). The code channels are typically added at this point, before the baseband filtering. The complex-valued chip sequence is then filtered with an RRC ( $\alpha = 0.22$ ) filter, and the result is applied to the QPSK modulator<sup>2</sup>. The final constellation at the RF does not typically look like QPSK, or any other known constellation, except for some very specific channel configurations. For example, a signal with a single code channel does map onto a 45°-rotated QPSK constellation, as shown in Figure 19. The rotation is caused by the complex scrambling. Since the receiver does not care about the absolute phase rotation, it effectively sees a QPSK constellation.

Therefore, you can use a regular QPSK EVM measurement to get some indication of the modulation quality at the chip level for a single-channel signal. More complex signals cannot be analyzed with this measurement. QPSK EVM compares the measured chip signal at the RF with an ideal QPSK reference (see Figure 18).

The QPSK EVM measurement does not descramble and despread the signal into symbols and back into chips to calculate the appropriate reference. Therefore, it can detect baseband filtering, modulation, and RF impairments, but it does not detect OVSF spreading or complex scrambling errors.

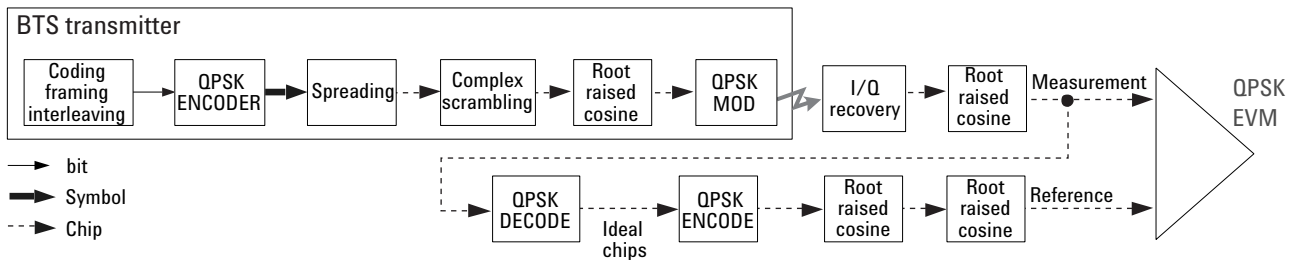

**Figure 18. Process to calculate QPSK EVM for a W-CDMA DL signal**

If it is not possible to despread and descramble the signal, the QPSK EVM measurement may be the only choice. In that sense, the QPSK EVM measurement can be useful to RF designers or system integrators to evaluate the modulation quality of the analog section of the transmitter when the spreading or scrambling algorithms are not available or do not work properly. For example, Figure 19 shows the QPSK EVM measurement and vector diagram for a W-CDMA DL signal (one DPCH) with and without an I/Q gain error.

1. QPSK encoding, in this case, refers to the process of mapping the bits for a channel onto the I (or the Q) path in parallel.  
 2. QPSK modulation, in this case, refers to the upconversion process. The process of modulating the RF carrier with the I/Q baseband signal.

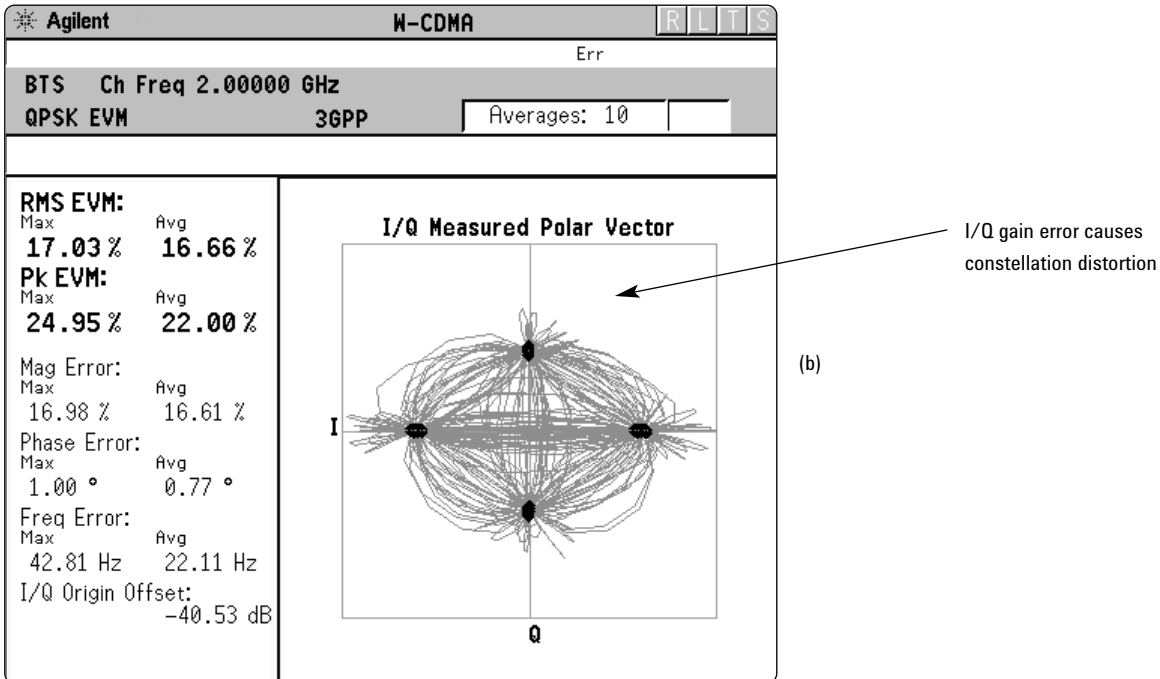
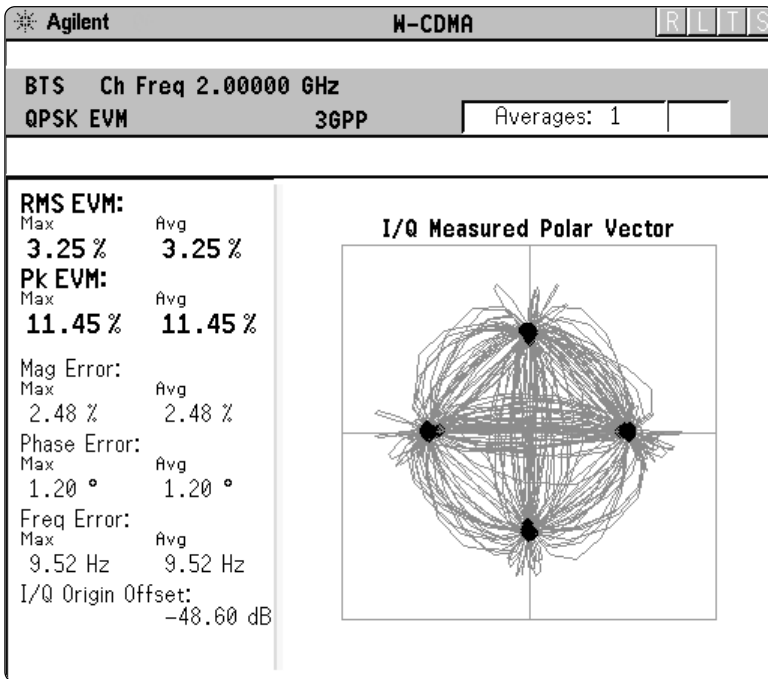

**Figure 19. Vector diagram and QPSK EVM measurement for a W CDMA DL signal with a single DPCH. (a) Transmitter without any impairment. (b) Transmitter with an I/Q gain error.**

Depending on the nature of the error, you can use the vector diagram, the error vector versus time or frequency, the magnitude error versus time, or the phase error versus time to troubleshoot it. For example, most I/Q impairments (such as the I/Q gain error in Figure 19) can be easily recognized by looking at the vector diagram, while in-channel spurious signals can be detected by analyzing the error vector spectrum.

### 2.3.2 Composite EVM

Although measuring EVM for a signal with a single code channel may be useful, in general, we are interested in the overall modulation quality of the transmitter for any channel configuration. The constellation of this signal will vary depending on its channel configuration. The measurement of choice in that case is the composite EVM measurement. The EVM measurement corresponds to the modulation accuracy conformance test specified in the 3GPP specifications.

To evaluate the modulation accuracy of a W-CDMA multi-channel DL signal, we again need to synthesize a reference signal. The signal under test is downconverted (the baseband I and Q signals are recovered) and passed through a root raised cosine receive filter. Active channels are descrambled, despread, and QPSK decoded to bits (see Figure 20).

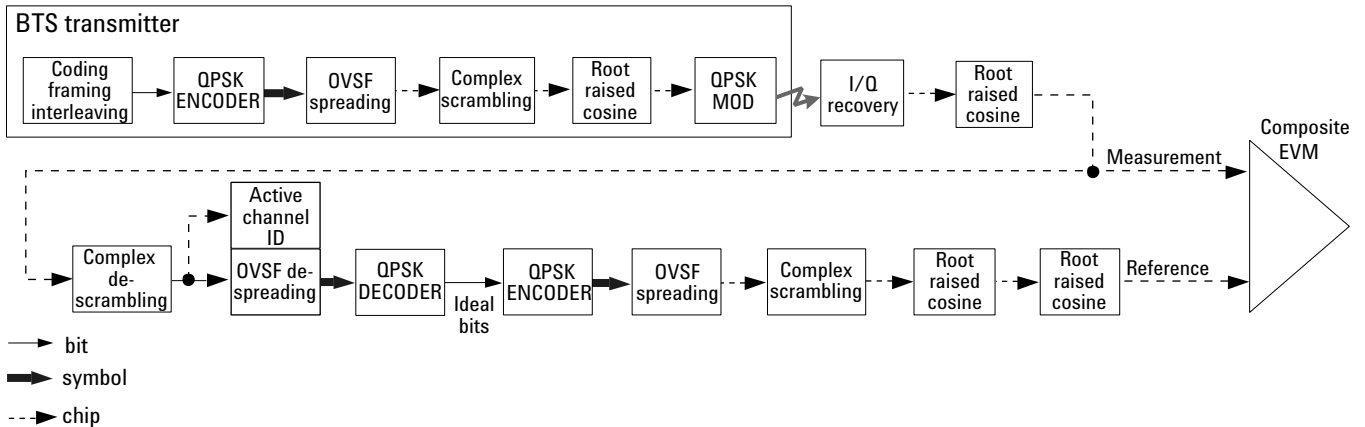

**Figure 20. Process to calculate composite EVM for a W-CDMA DL signal**

The despread bits are “perfectly” remodulated to produce the required reference signal at the chip level. The reference signal is then subtracted from the measured signal to produce a time record of error phasors. The square root of the ratio of the mean power of the error signal to the mean power of the reference signal is computed and expressed as a percentage EVM.

The composite EVM measurement accounts for all spreading and scrambling problems in the active channels, and for all baseband, IF, and RF impairments in the transmitter chain.

To make a composite EVM measurement, the W-CDMA DL signal must contain either the SCH or the CPICH. Otherwise, the analyzer cannot synchronize to the signal and calculate the appropriate reference. In that case, you can use QPSK EVM to measure the RF performance for a single channel (for example, the CPICH or a DPCH), as mentioned earlier.

There are several situations where you will want to use the composite EVM measurement (and its related vector diagram, phase error and magnitude error metrics, etc.), instead of a QPSK EVM measurement:

- 1. To evaluate the quality of the transmitter for a multi-channel signal.** This is particularly important for RF designers who need to test the RF section (or components) of the transmitter using realistic signals with correct statistics. As mentioned earlier, the PAR of the signal increases as the number of channels increases. By measuring modulation quality on a multi-channel signal you can analyze the performance of the RF design for W-CDMA DL signals with different levels of stress (different CCDFs). Evaluating the modulation quality of multi-channel signals is also important for the baseband designers to analyze the performance of multi-board baseband designs. For example, a small timing error in the clock

synchronization between channels on different boards can be detected as a decrease in modulation quality. The channel configuration required in the specifications for the EVM modulation quality conformance test is provided by test model 4. Test model 4 consists of the P-CCPCH, the SCH, and optionally, the CPICH. Figure 21(a) shows the vector diagram and composite EVM measurement for test model 4 (P-CCPCH and SCH), as required by the specifications. However, to obtain a more meaningful measure of the modulation quality for a real life DL signal, the composite EVM measurement should be performed on a signal with multiple channels, as shown in Figure 21(b) for a signal with the P-CCPCH, SCH, CPICH, and 32 DPCHs.

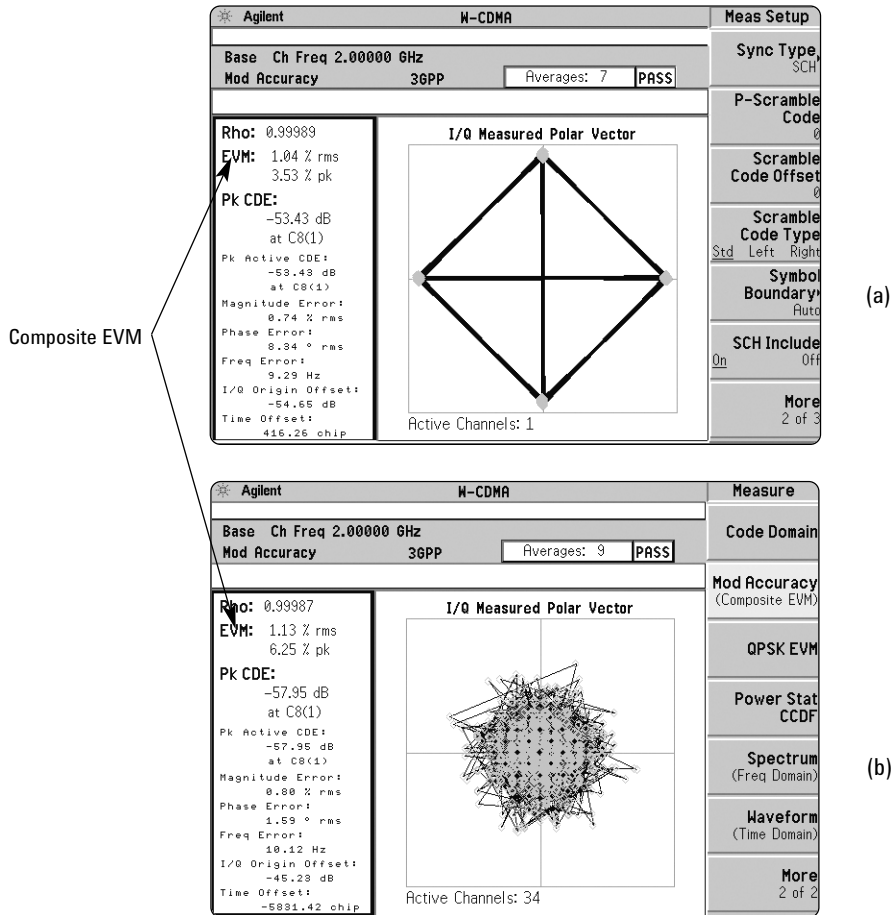

**Figure 21. Vector diagram and composite EVM measurement for a W CDMA DL signal with (a) the P CCPCH/SCH, and (b) the P CCPCH/SCH, CPICH, and 32 DPCHs.**

2. **To detect spreading or scrambling errors.** Depending on the degree of the error, the analyzer may show an intermittent unlock condition or may not be able to lock at all when trying to perform a composite EVM measurement. This is mainly useful to system integrators to determine errors in the spreading and scrambling. If this problem occurs, the QPSK EVM measurement can be used to confirm that the rest of the transmitter is working as expected. If the scrambling or spreading error does not cause an unlock measurement condition, the error vector versus time display can be used to find the problematic chip.
3. **To detect certain problems between the baseband and RF sections.** This is mainly useful for system integrators. For example, local oscillator (LO) instability caused by interference from digital signals can be detected with QPSK EVM. However, the QPSK EVM measurement will not detect problems that require the measurement to synchronize with a bit sequence. For example, I/Q swapped (reversed I and Q) errors will look perfectly normal if a QPSK EVM measurement is used. Conversely, it will cause an unlock condition when performing a composite EVM measurement.

Composite EVM is useful throughout the development, performance verification, and manufacturing phases of the BTS life cycle as a single figure of merit of the composite waveform as a whole. However code-by-code composition of the multiplex is also of interest. The primary means of investigating this is to look at the distribution of power in the code domain.

### 2.3.3 Code domain power

Code domain power is an analysis of the distribution of signal power across the set of code channels, normalized to the total signal power. To analyze the composite waveform, each channel is decoded using a code-correlation algorithm. This algorithm determines the correlation coefficient factor for each code. Once the channels are decoded, the power in each code channel is determined.

In W-CDMA, the measurement is complicated by the fact that the length of the OVFSF codes, or SF, varies to accommodate the different data rates. As the user rate increases the symbol period is shorter. Since the final chip rate is constant, fewer OVFSF code chips are accommodated within the symbol period – the SF is smaller. The spreading factor can be 4, 8, 16, 32, 64, 128, 256, or 512 corresponding to DPCH symbol rates from 960 kbps down to 7.5 kbps.

Eight sets of spreading codes are specified, one set for each SF. The OVFSF codes can be allocated using the code tree of Figure 22. Each code is denoted by  $C_{ch,SF,n}$ . For example,  $C_{ch,4,2}$  means channelization code, SF = 4, code number two.

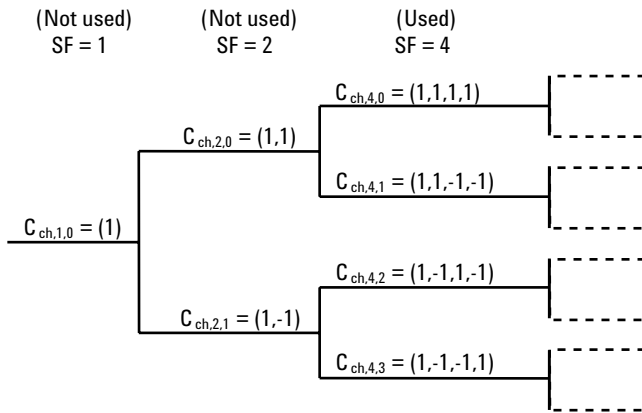

Figure 22. Code tree generation of OVFSF codes

In this tree, OVFSF codes of a certain SF are obtained by copying the “mother-branch” code of the previous SF and repeating or inverting it. For example,  $C_{ch,4,2} = (1,-1,1,-1)$  is obtained by repeating  $C_{ch,2,1} = (1,-1)$ , while  $C_{ch,4,3} = (1,-1,-1,1)$  is obtained by copying  $C_{ch,2,1} = (1,-1)$  and inverting it. This code generation technique is known as reverse-bit method.

One of the consequences of using variable SFs is that a shorter code precludes using all longer codes derived from it. Figure 23 illustrates this concept. If a high data rate channel using a code of SF = 4 (1,1,-1,-1) is selected, all lower data rate channels using longer codes that start with 1,1,-1,-1, have to be inactive because they are not orthogonal.

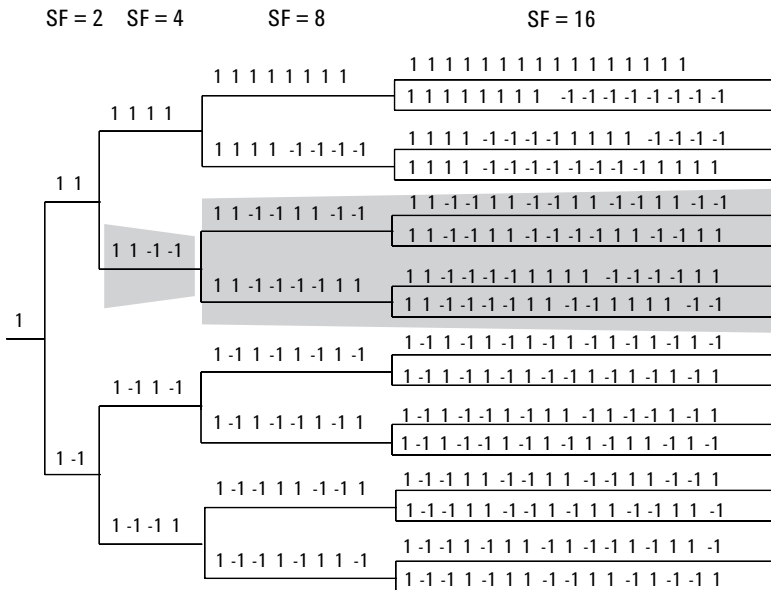

Figure 23. Effects of using variable SFs

In terms of code capacity, channels with higher data rates (lower SFs) occupy more code space. For example,  $C_{ch,4,1}$  occupies two times more code space than  $C_{ch,8,2}$ , and four times more code space than  $C_{ch,16,4}$ . In the code domain power display, the wider bars represent codes with low SF, which occupy more code space. Figure 24 shows the code domain power display for a signal with the P-CCPCH/SCH, CPICH, one DPCH at 30 kbps with SF = 128 ( $C_{ch,128,8}$ ), and one DPCH at 120 kbps with SF = 32 ( $C_{ch,32,15}$ ). The marker is positioned on the “wide” code channel ( $C_{ch,32,15}$ ), which indicates a high data rate (120 kbps). In order to provide this display, the analyzer must be able to identify the SFs of the active code channels.

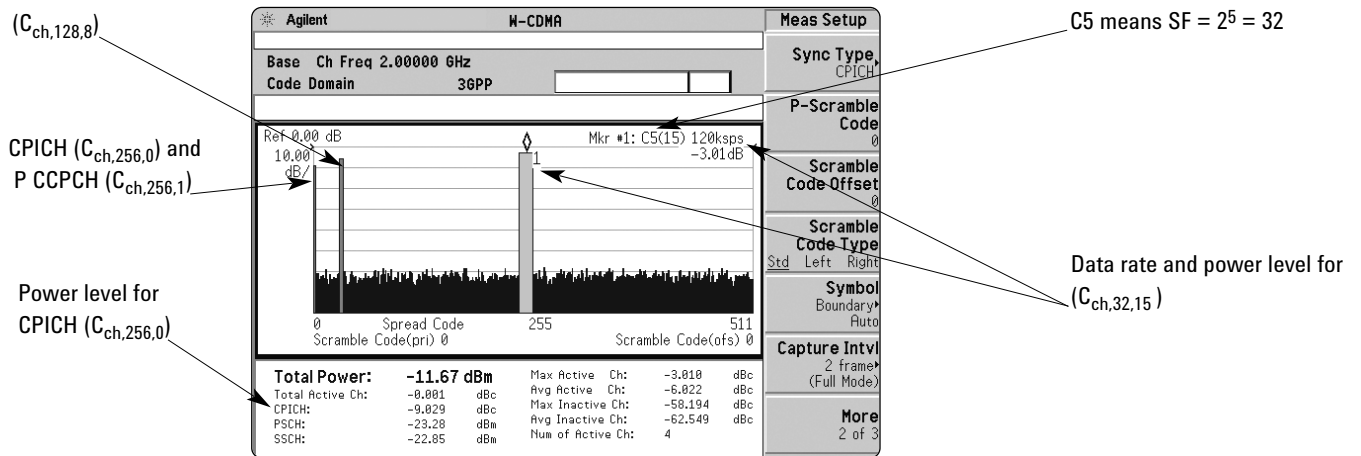

Figure 24. Code domain power display for a signal with the P-CCPCH/SCH, CPICH, and two DPCHs ( $C_{ch,32,15}$  and  $C_{ch,32,15}$ ).

The code domain power measurement helps you not only verify that each OVSF channel is operating at its proper level, but also identify problems throughout the transmitter design from the coding to the RF section. In particular, the levels of the inactive channels can provide useful information about specific impairments. Ideally, the level for the inactive channels would be zero. In reality, signal and system imperfections compromise the code orthogonality and result in a certain amount of the signal power projecting onto inactive codes. A real signal will also have a certain noise level, which will project more or less evenly onto all codes randomly.



The projection of the error is interesting because it enables us to see how the error power is distributed in the code domain. You want the error power to be evenly distributed throughout the code domain, rather than concentrated in a few codes, to avoid code-dependent channel quality variations.

One cause of uneven distribution of error power is power amplifier non-linearity. Signal compression causes what is known as code mixing. This effect can be predicted mathematically. In essence, energy is lost from the active channels and appears in those channels with codes that are the exclusive OR (XOR) of the active channel codes. In Figure 25, amplifier compression on a signal with channels  $C_{ch,256,0}$  (CPICH),  $C_{ch,256,1}$  (P-CCPCH),  $C_{ch,32,8}$  and  $C_{ch,32,14}$  causes energy in the code space that would be occupied by  $C_{ch,32,6}$ .

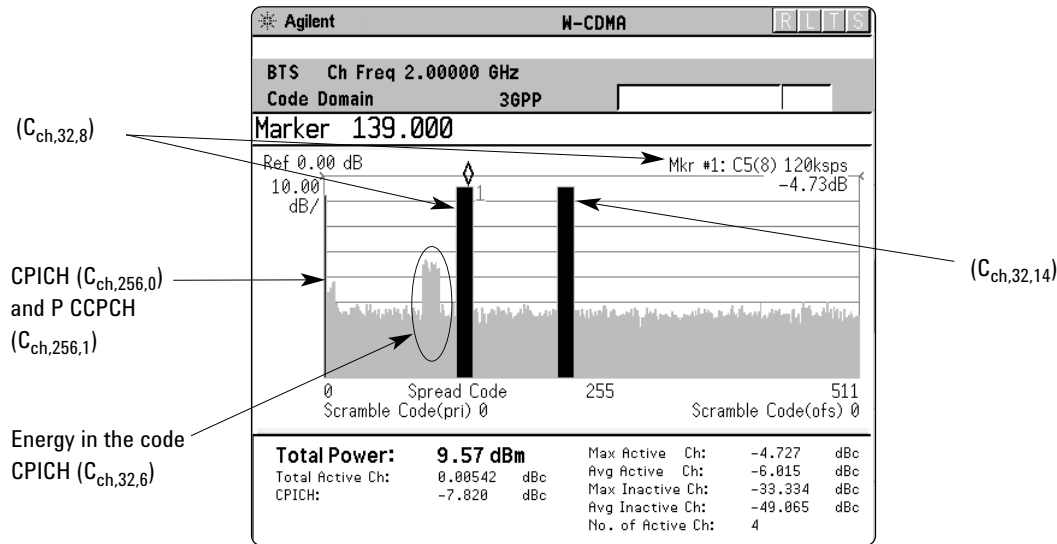
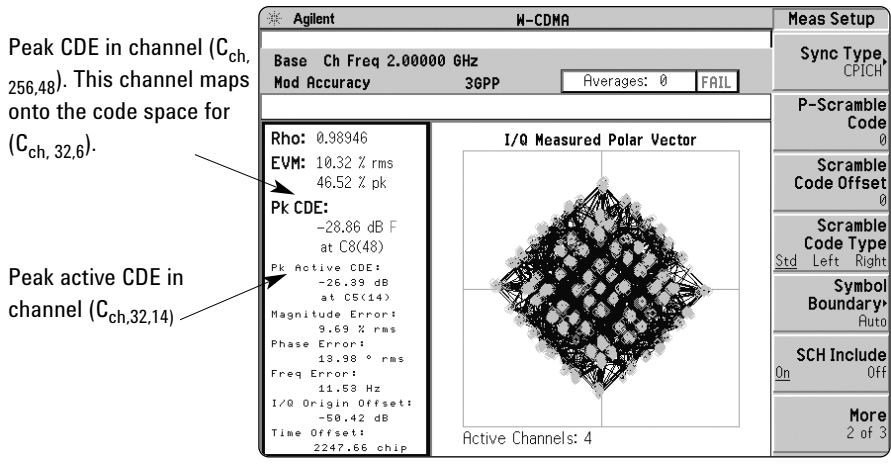

Figure 25. Code domain power display for a signal with the P CCPCH/SCH, CPICH, and two DPCHs ( $C_{ch,32,8}$  and  $C_{ch,32,14}$ ).

### 2.3.4 Peak code domain error

In W-CDMA specifically, to address the possibility of uneven error power distribution, the composite EVM measurement has been supplemented by another test called peak code domain error, which specifies a limit for the error power in any one code.

To provide this metric, the analyzer must project the error vector power on each code channel at a SF of 256. The peak code domain power is then calculated from the code that returns the largest error power relative to the reference. Figure 26 shows the peak code domain error, in combination with the composite EVM for the same signal with the code-mixing problem above.



**Figure 26. Peak code domain error and composite EVM for W CDMA DL signal with the P CCPCH/SCH, CPICH, and two DPCHs ( $C_{ch,32,8}$  and  $C_{ch,32,14}$ ). Signal with compression impairment.**

Apart from looking at the code domain power and peak code domain error, it is useful to analyze a specific code channel. The following sections describe some analysis tools and how they can be applied. Figure 27 shows how these measurements are calculated.

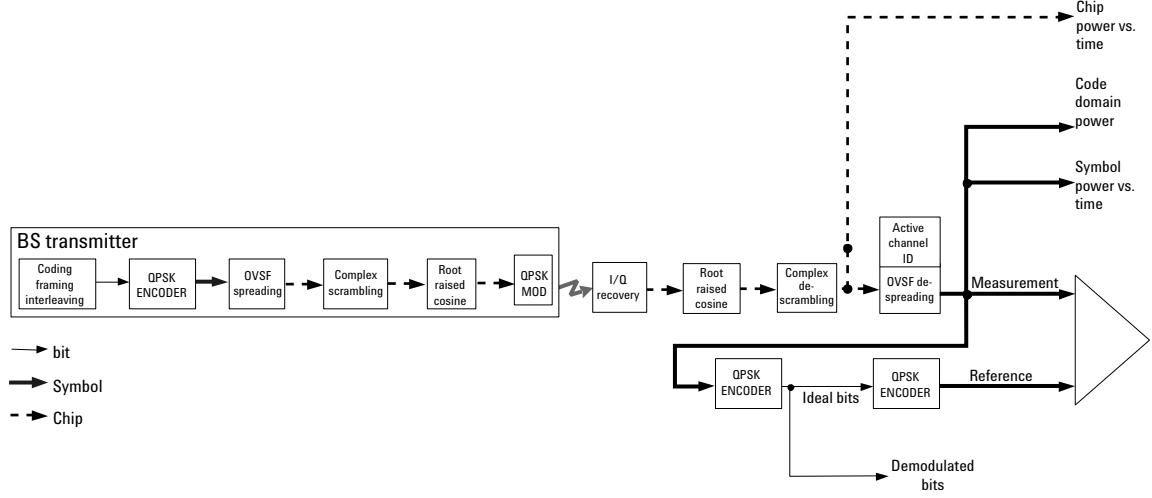

**Figure 27. Process to calculate code domain power, symbol EVM, symbol power versus time, chip power versus time, and demodulated bits**

### 2.3.5 Symbol EVM

By descrambling and despreding the signal you can analyze the constellation and EVM for a specific code channel at the symbol level, even in the presence of multiple codes. The measured signal is descrambled and despread. The phase trajectory of the ideal symbol reference is then calculated and compared to the trajectory of the measured despread symbols (Figure 27).

An impairment that affects symbol EVM will also affect the composite EVM. For example, an amplifier compression problem will appear both in the composite EVM and in the symbol EVM measurement. However, because of the spreading gain, symbol EVM will mute the impairment. So, why use symbol EVM?

Symbol EVM provides the bridge between RF and demodulated bits. Since it includes the spreading gain, it provides baseband engineers a measure of modulation quality closer to real-life performance. In this sense, you can think of it as the actual quality that the user in that channel will experience (similar to the reciprocal of bit error rate (BER)).

The relationship between symbol EVM and chip EVM depends on the SF. At low SFs (high data rates) chip modulation errors have a significant effect on symbol EVM. At high SFs, chip modulation errors have little effect on symbol EVM. In this sense, it is particularly useful to baseband DSP engineers to evaluate symbol quality and analyze how specific impairments affect the quality of channels at different data rates. For example, Figure 28 shows the symbol EVM for a signal with a high-frequency phase error problem, for a channel at 15 kbps with SF = 256, and a channel at 480 kbps with SF = 8. The symbol EVM is higher for the higher data rate channel.

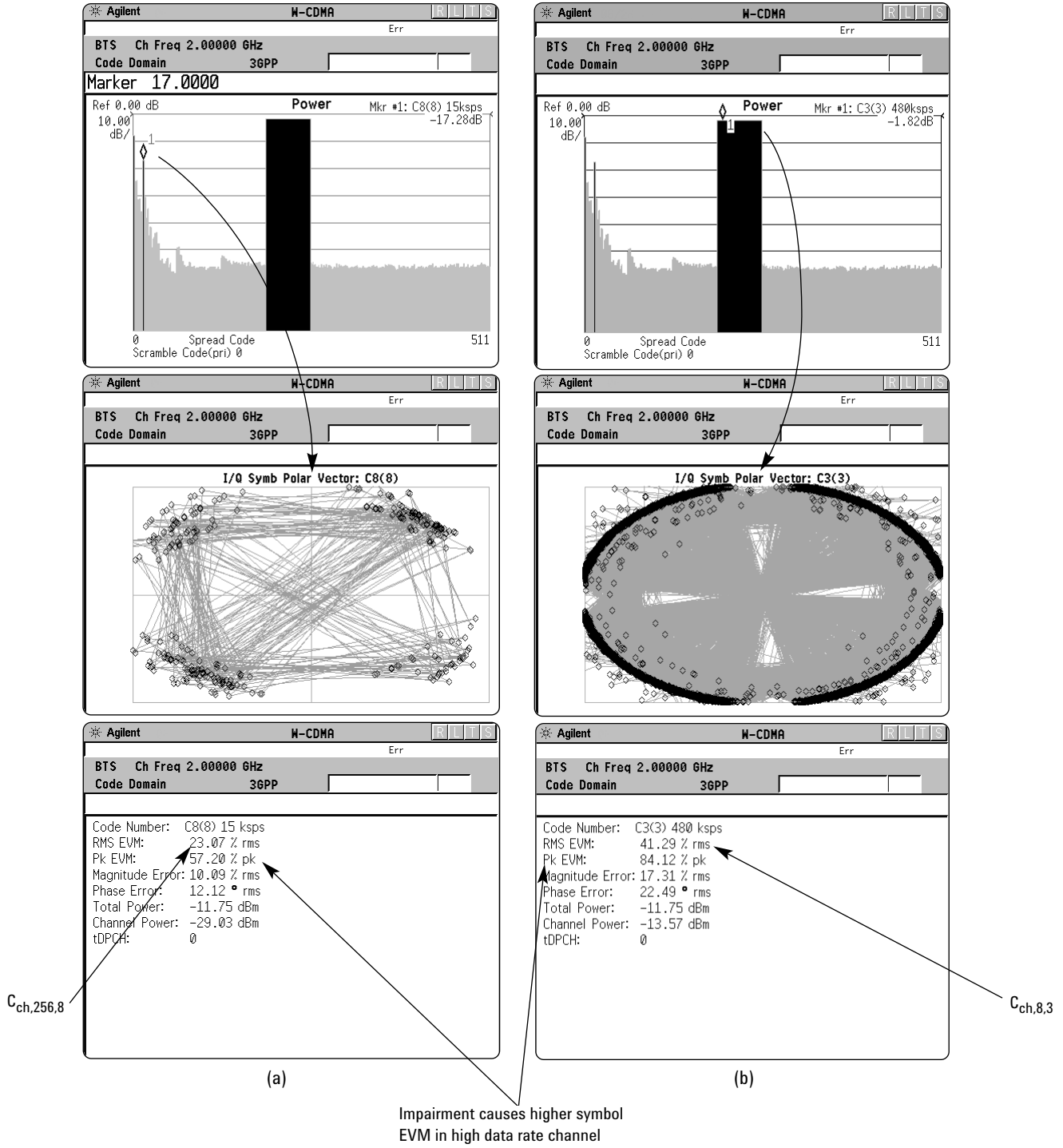

Figure 28. Code domain power measurement of a W CDMA DL signal with the P CCPCH/SCH, CPICH, and two DPCHs (C<sub>ch,256,8</sub> and C<sub>ch,8,3</sub>). (a) Symbol EVM for the DPCH at 15 kbps (C<sub>ch,256,8</sub>). (b) Symbol EVM for the DPCH at 480 kbps (C<sub>ch,8,3</sub>).

### 2.3.6 Symbol power versus time

Each DL DPCH uses one of the slot structures shown in Table 1 in *normal mode*. For example, the DPCH may contain TFCI bits, TPC bits, and Pilot bits. These fields can have independent gain settings, as shown in the example in Figure 29.

Slot format #i	Channel bit rate (kbps)	Channel symbol rate (kbps)	SF	Bits/slot	DPDCH bits/slot		DPCCH bits/slot			Transmitted slots per radio frame $N_{Tr}$
					$N_{data1}$	$N_{data2}$	$N_{TPC}$	$N_{TFCI}$	$N_{pilot}$	
0	15	7.5	512	10	0	4	2	0	4	15
1	15	7.5	512	10	0	2	2	2	4	15
2	30	15	256	20	2	14	2	0	2	15
3	30	15	256	20	2	14	2	2	2	15
4	30	15	256	20	2	12	2	0	4	15
5	30	15	256	20	2	12	2	2	4	15
6	30	15	256	20	2	8	2	0	8	15
7	30	15	256	20	2	6	2	2	8	15
8	60	30	128	40	6	28	2	0	4	15
9	60	30	128	40	6	26	2	2	4	15
10	60	30	128	40	6	24	2	0	8	15
11	60	30	128	40	6	22	2	2	8	15
12	120	60	64	80	12	48	4	8*	8	15
13	240	120	32	160	28	120	4	8*	8	15
14	480	240	16	320	56	240	8	8*	16	15
15	960	480	8	640	120	496	8	8*	16	15
16	1920	960	4	1280	248	1008	8	8*	16	15

\* If TFCI bits are not used, then discontinuous transmission (DTX) bits shall be used.

Table 1. DL slot structures for DPCH in normal mode

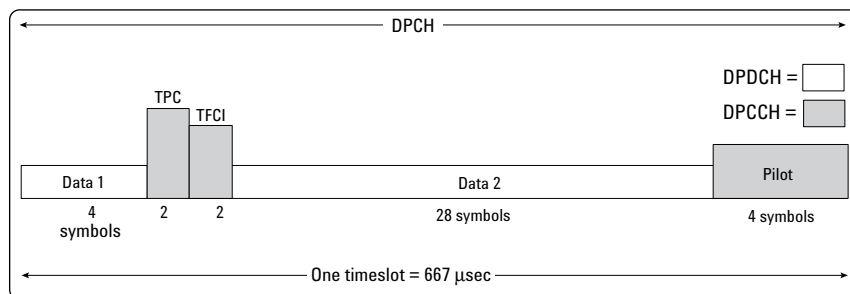

Figure 29. Example of variable power levels for DL DPCH fields

You can verify the accuracy of the power offsets for the different fields by looking at the symbol power versus time for a specific code channel (Figure 30).

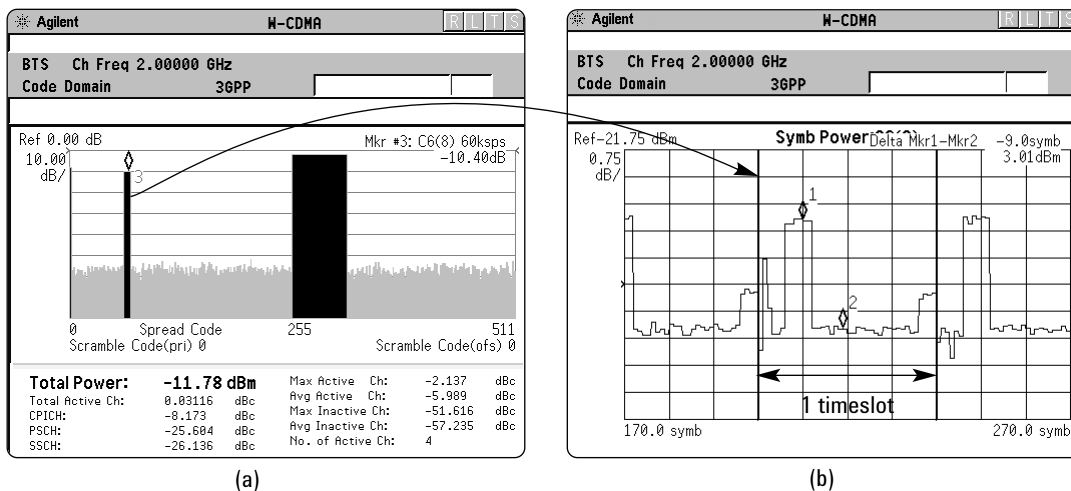
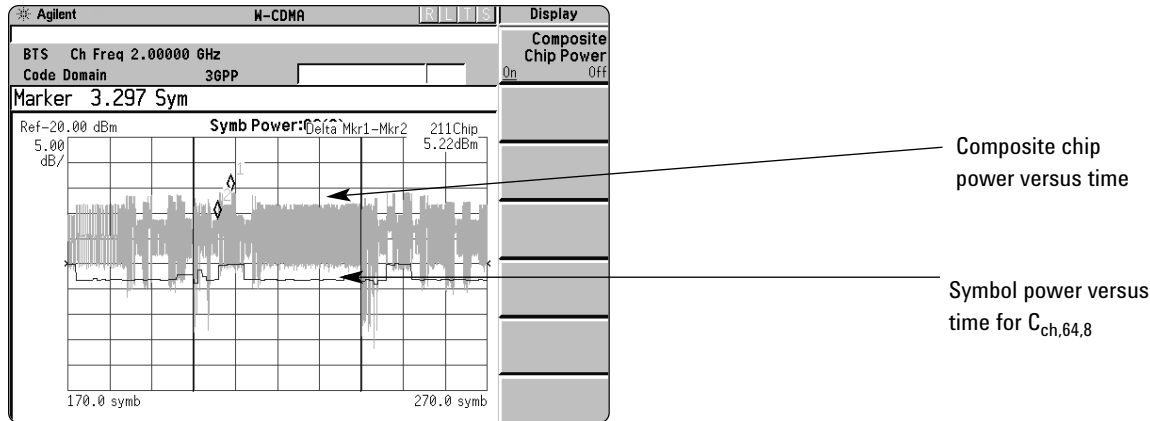

Figure 30. (a) Code domain power measurement of a W CDMA DL signal with the P CCPCH/SCH, CPICH and two DPCHs ( $C_{ch,64,8}$  and  $C_{ch,8,4}$ ). (b) Symbol power versus time for the DPCH at 60 kbps ( $C_{ch,64,8}$ ).

The symbol power versus time measurement can be used to monitor the power and response of the BTS power control system. Averaging the symbol power over one time-slot provides the code domain power for the code channel. Code domain power is the recommended method to perform the power control steps conformance test that requires measuring the accuracy of the power steps of a particular code channel as a response to a series of power control commands.

Figure 31 shows the despread symbol power in combination with the composite (total) chip power for a DL signal. Chip power represents the total power of the signal at the chip rate. Analyzing the symbol power for a channel in combination with the total chip power versus time is particularly useful for system integrators to analyze the power amplifier response (ripple) to power offsets or to a power control command.



**Figure 31. Chip power versus time for a signal with the P CCPCH/SCH, CPICH, and two DPCHs ( $C_{ch,64,8}$  and  $C_{ch,8,4}$ ) and symbol power versus time for the channel at 60 kbps ( $C_{ch,64,8}$ )**

### 2.3.7 Demodulated bits

By obtaining the demodulated symbols after descrambling and despreading for each code channel, the correct symbol patterns can be verified. As shown in Table 1, the DL DPCCCH can have different slot structures. You can verify if the bits for the different fields (Pilot, TFCI, TPC, etc.) are correct by using the demodulated bits measurement (Figure 32).

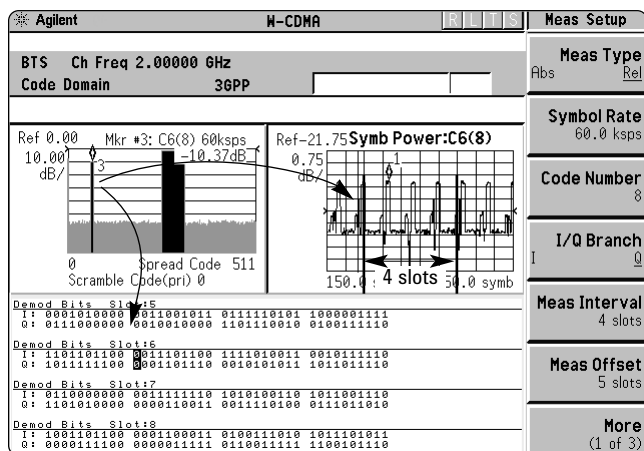

**Figure 32. Code domain power measurement of a W CDMA DL signal with the P CCPCH/SCH, CPICH, and two DPCHs ( $C_{ch,64,8}$  and  $C_{ch,8,4}$ ) and symbol power versus time coupled with demodulated bits for the DPCH at 60 kbps ( $C_{ch,64,8}$ ).**

Demodulated bits is an important troubleshooting tool for baseband engineers to identify coding and interleaving errors. In many cases, it can help you clarify situations where the BTS and UE are having problems communicating with each other. Analyzing the demodulated bits may verify whether the error is coming from the BTS coding and interleaving or the UE de-interleaving and decoding process.

### 2.3.8 Power control in the downlink

Power control limits the transmitted power level resulting in minimized interference levels and greater system capacity. An excess error of the power control decreases the system capacity. There are three different power control loops in the DL: outer loop power control, open loop power control, and inner loop power control. Outer loop power control is used by the network to set a signal quality level based on the desired Quality of Service (QoS). The DL open loop power control sets the initial power of the DL channels. It receives DL measurement reports from the UE.

The DL inner loop power control sets the power of the DL DPCHs. In order to minimize interference, the BTS transmitter adjusts its code channel power in accordance with one of more TPC commands received in the UL. Power control commands are sent at every slot.

There are several conformance tests that are required by the specifications to verify the performance of the DL inner loop power control: 6.4.1 Inner loop power control, 6.4.2 Power control steps, and 6.4.3 Power control dynamic range in. In order to perform these tests, a code domain power measurement is required. The transmitter must be set up as indicated by test model 2. This test model includes the SCH, which is only on 10% of the slot period. The SCH is not orthogonal to the rest of the code channels. Therefore, when the power level of code channel is measured as average power in a slot, the SCH energy leakage is spread out in code domain as a noise floor.

6.4.3 Power control dynamic range is required in the range between  $-3$  dB to  $-28$  dB. The SCH leakage results in 0.21 dB of noise level for a DPCH at  $-28$  dB. This means that when DPCH is measured at  $-28$  dB level, 0.21 dB of noise power is always added on average. In order to avoid this problem, gated code domain power can be used. Gated code domain power measures the power only for the 90% slot period for which the SCH is off. Figure 34 shows a gated code domain power measurement for test model 2 with the DPCH at  $-28$  dB. The display shows both the gated code domain power result ( $-28$  dB) and the non-gated power result for that channel ( $-27.63$  dB). The results can change from slot to slot, so the measurement is averaged over a frame (15 slots) to get more stable results.

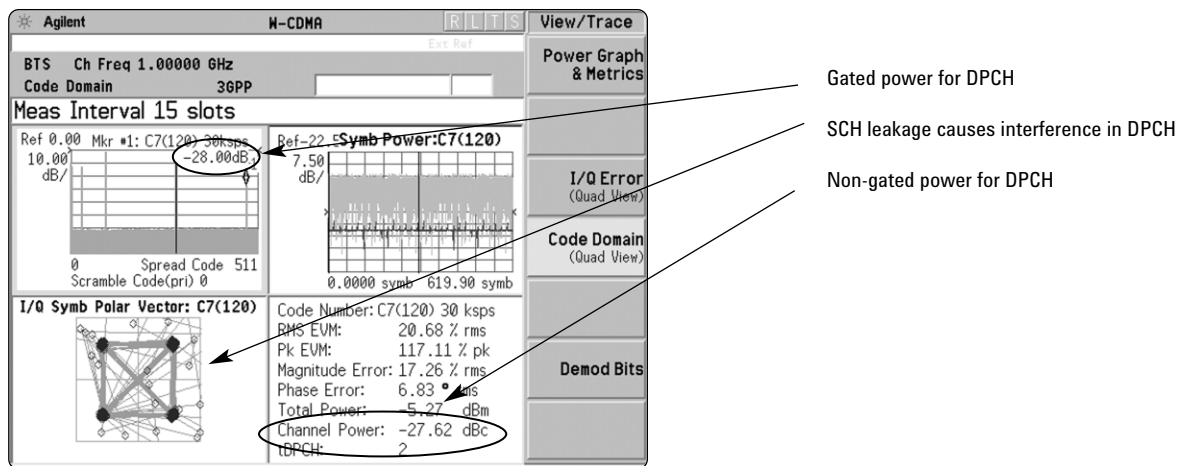

Figure 33. Gated and non-gated power for DPCH for power control dynamic range

## 2.4 Measuring receiver performance

In CDMA systems the receiver demodulation process is more complex than in TDMA systems. The BTS receiver must use correlation and descrambling algorithms to recover the bits from the signal transmitted by the UE.

Unlike 2G systems, the UE can transmit more than one physical channel in order to account for the high data rates. The expectation is that most of the high data rate traffic will occur in the DL, so the UE will probably now work at full capacity most of the time (it will not use all the available channels).

The minimum configuration for the UL consists of the DPCCH and one DPDCH. The DPDCH and the DPCCH can use any of the slot formats shown in tables 2 and 3. In compressed mode, DPCCH slot formats with TFCI fields are changed. There are two possible compressed slot formats for each normal slot format. They are labeled A and B and the selection between them is dependent on the number of slots that are transmitted in each frame in compressed mode.

Slot form at #i	Channel bit rate (kbps)	Channel symbol rate (ksps)	SF	Bits/frame	Bits/slots	N <sub>data</sub>
0	15	15	256	150	10	10
1	30	30	128	300	20	20
2	60	60	64	600	40	40
3	120	120	32	1200	80	80
4	240	240	16	2400	160	160
5	480	480	8	4800	320	320
6	960	960	4	9600	640	640

Table 2. UL DPDCH fields

Slot form at #i	Channel bit rate (kbps)	Channel symbol rate (ksps)	SF	Bits/frame	Bits/slots	N <sub>pilot</sub>	N <sub>TPC</sub>	N <sub>TFCI</sub>	N <sub>FBI</sub>	Transmitted slots per radio frame
0	15	15	256	150	10	6	2	2	0	15
0A	15	15	256	150	10	5	2	3	0	10-14
0B	15	15	256	150	10	4	2	4	0	8-9
1	15	15	256	150	10	8	2	0	0	8-15
2	15	15	256	150	10	5	2	2	1	15
2A	15	15	256	150	10	4	2	3	1	10-14
2B	15	15	256	150	10	3	2	4	1	8-9
3	15	15	256	150	10	7	2	0	1	8-15
4	15	15	256	150	10	6	4	0	1	8-15

Table 3. UL DPCCH fields in normal and compressed mode

The figure of merit in the 3GPP specifications is bit error rate (BER) for receiver characteristics, and block error rate (BLER) for performance requirements. The receiver characteristics tests include reference sensitivity level, ACS, and blocking characteristics. Performance tests analyze the receiver performance for several UL reference measurement channels under specified propagation conditions. Some examples of performance tests are demodulation of DCH in multi-path fading propagation conditions and demodulation of DCH in birth/death propagation conditions.

This chapter explains the differences between BER, BLER and R. Also included is a description of the appropriate stimulus signals for the receiver characteristics and the performance tests. For a summary of the test setup required for each of the receiver characteristics and the performance tests, see 3GPP TS25.141.

In addition to the conformance tests in the specifications, additional receiver testing is needed to verify the performance and the functionality of different aspects of the receiver design. This chapter also discusses different tests that can be performed to verify the functionality and performance of different aspects of your W-CDMA BTS receiver subsystem and system design, and the stimulus signal requirements for these tests.

For a description of the receiver test capabilities of Agilent design and test solutions see Appendix B.

### 2.4.1 Bit error rate (BER) versus block error rate (BLER)

BER and BLER – or Frame Error Ratio (FER) in IS-95 or cdma2000—are two related methods of measuring the ability of a digital receiver to recover the information in the received signal. The subject of which figure of merit to use has caused considerable debate in the CDMA community. Both measures have value; though for slightly different applications.

BER is defined as the ratio of the bits wrongly received to all data bits sent. The bits are the information bits above the convolutional/turbo decoder (see Figure 34).

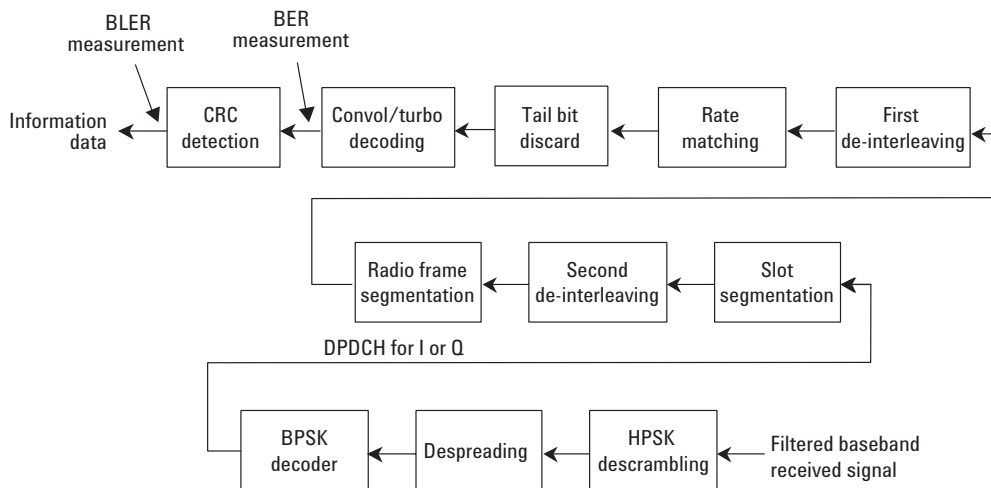

Figure 34. BER and BLER measurements in the W-CDMA BTS receiver chain for a DPDCH.

BER is typically used to evaluate receiver RF performance during radio development. During the early stages of W-CDMA technology development, it was also extensively used in system simulation of the W-CDMA reference measurement channels. For these reasons, BER tests remain in the 3GPP specifications, as the figure of merit for the receiver characteristics measurements. BLER is defined as the ratio of the number of erroneous blocks received to the total number of blocks sent. An erroneous block is defined as a transport block, the cyclic redundancy check (CRC) of what is wrong. CDMA systems, such as cdma2000 and W-CDMA, operate with a large degree of coding gain, which helps the receiver recover information in the presence of noise and interference.

When the goal is to estimate or monitor the overall system capacity, this coding gain must be taken into account. In that case, the Block or Frame Error Rate is a more useful measure of the receiver's effectiveness; and thus, of the capacity of the overall system of which the receiver is a part. BLER is an important measure when evaluating a new system design or coding and decoding elements for a system. Because it includes



more coding gain, BLER will offer a somewhat less gradual slope of measured result versus receiver noise figure than BER. If BLER is used for monitoring process quality the higher coding gain will result in little warning of impending problems; the test results will look very good until the process quality degrades past a threshold, at which point there will suddenly be a substantial number of failures. For this reason, BLER is used during system design evaluation and RF performance conformance testing, but not during manufacturing.

In order to map throughput (R) to BLER:

- a) In measurement practice the BS indicates successfully received information bit payload by signalling an ACK to the tester. If payload is received, but damaged and cannot be decoded, the BS signals a NACK.
- b) Only the ACK and NACK signals, not the data bits received, are accessible. The number of bits is known from the payload that was sent.
- c) For fixed reference channel the number of bits in a Transmission Time Interval (TTI) is fixed during one test.
- d) The total time in the measurement interval is composed of successful TTIs (ACK), unsuccessful TTIs (NACK) and DTX-TTIs.
- e) DTX-TTIs occur statistically when the BS is not responding ACK or NACK where it should (statDTX). This may happen when the BS misses data that are intended for it.

The pass / fail decision is done by observing the numbers of NACKs, ACKs and statDTXs. The ratio

$$\frac{\text{NACK} + \text{statDTX}}{\text{NACK} + \text{statDTX} + \text{ACK}}$$

is the Block Error Ratio BLER. Taking into account the time consumed by the ACK-, NACK-, and statDTX-TTIs, BLER can be mapped unambiguously to throughput for any single FRC test.

The key performance metric for HSUPA is demodulation of the E-DPDCH in multipath fading conditions. The performance requirement of the E-DPDCH in multipath fading conditions is determined by the minimum throughput, R. The test shall verify the receiver's ability to receive the test signal under slow multipath fading propagation conditions with a throughput not below a specified limit. For HSUPA closed loop HARQ feedback is the technique used to maximize throughput and this must be functional to measure R.

### Hybrid ARQ

Hybrid automatic repeat request (HARQ) is a technique combining feed-forward error correction (FEC) and ARQ methods that save information from previous failed attempts to be used in future decoding. HARQ is an implicit link-adaptation technique. Whereas adaptive modulation and coding (AMC) uses explicit carrier to interference ratio (C/I) or similar measurements to set the modulation and coding format, HARQ uses link-layer acknowledgements (ACK/NACK) for re-transmission decisions. Put another way, AMC provides the coarse data-rate selection, while HARQ provides fine data-rate adjustment based on channel conditions. See Figure 34a.

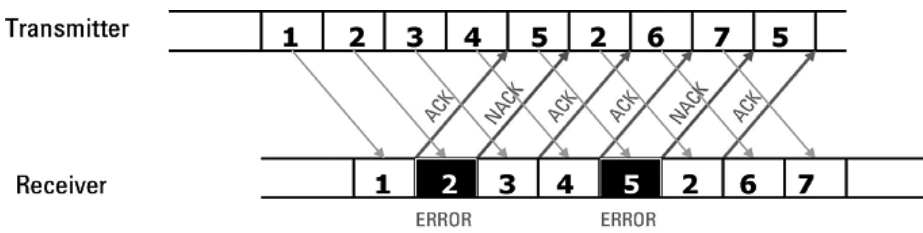
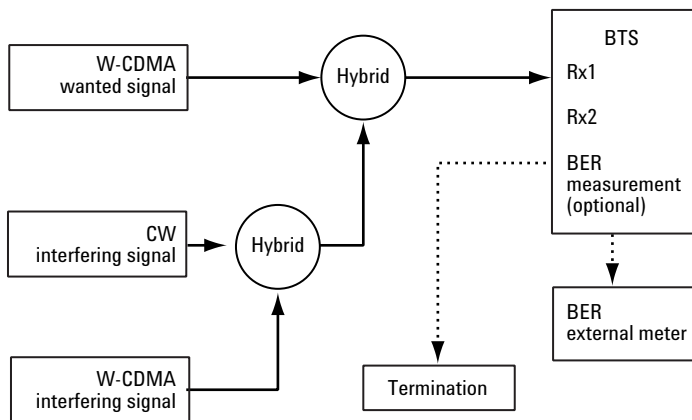

Figure 34a. HARQ uses link-layer acknowledgments to make re-transmission decisions

## 2.4.2 Stimulus signals for receiver characteristics and performance tests

In order to make BER or BLER measurements, the specifications require a fully-coded signal as the stimulus. In the case of the conformance tests, this signal must be configured as one of the reference measurement channels. All the receiver characteristics tests (from 7.2 to 7.8 in, except for 7.7 spurious emissions which does not require a stimulus) require the 12.2 kbps reference measurement channel only. Each of the performance requirement tests; however, must be performed for several reference measurement channels and fixed reference channels (see 3GPP TS 25.141 for coding structure and parameters). Whatever the reference measurement channel required is, a PN9 sequence must be used as the information data for the DTCH (or DCCH) and E-DCH.

In addition to the wanted signal with the appropriate reference measurement channel, some of the receiver characteristics tests require another signal (or two) to act as interference. Figure 35 shows the general setup needed to be able to perform all the receiver characteristics tests. Please note that not all the generators are needed for each test.



**Figure 35. General setup for receiver characteristics tests**

The interfering signal might be a W-CDMA modulated signal, a CW signal, or both at the same time. In the case of Dynamic Range, the interference is an Additive White Gaussian Noise (AWGN) signal in the same reception frequency channel. Having a single instrument generate both the wanted signal and the AWGN interference eliminates the technical issues associated with summing the signals from two different sources to achieve a proper noise ratio. Either the required carrier-to-noise ratio (C/N) or the energy-per-bit-to-noise ratio (Eb/No) for a transport channel such as the DCH, can then be set up directly as required by the specifications.

The difference between the C/N and the Eb/No is the processing gain for the channel, which depends on the transport channel data rate (Rb). So, C/N and the Eb/No are related by the following formula:

$$C/N = 10\log_{10}(R_b/3.84 \text{ Mcps}) + E_b/N_o \text{ (dB)}$$

For example, the mean power required for the reference measurement channel 12.2 kbps for the dynamic range test is -91 dB and the power for the interfering AWGN signal is -73 dBm/3.84 MHz. Therefore, the Eb/No required for the DCH is 7 dB. These calculations are not required if you use an instrument that allows you to directly set up both the C/N and the Eb/No. In that case, the C/N can be set in terms of Eb/No or vice versa.

The performance requirements tests apply to a BTS with and without dual antenna diversity. All the tests except for the Verification of internal BLER calculation require AWGN be added to each path. The specifications define the noise power based on the BTS class. The BLER cannot exceed the limits specified for the Eb/No levels specified for the DCH in each reference measurement channel. Similarly, the throughput R cannot exceed the limits specified for the E-DCH in each fixed reference channel. Certain tests require fading be applied to each path before the AWGN addition; Specifically the HSUPA throughput test requires slow multipath fading propagation conditions with a throughput not below a specified limit. The functional set-up diagram illustrated in Figure 35a shows a feedback signal going back to the BTS test labeled HARQ feedback. The HARQ feedback could be done as a digital feedback.

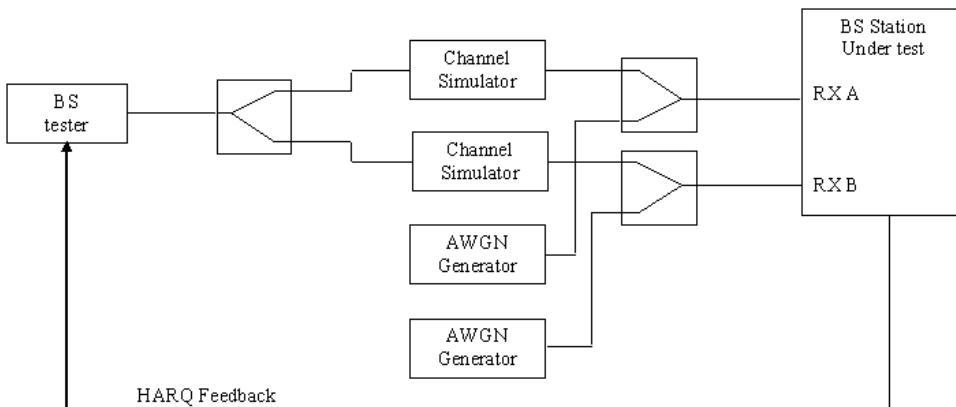

NOTE: The HARQ feedback could be done as an RF feedback or as a digital feedback. The HARQ feedback should be error free.

**Figure 35a. Functional set-up for demodulation of E-DPCH and E-DPCCH in multipath fading conditions for BS with Rx diversity**

### 2.4.3 Verification of internal BER and internal BLER calculation

The BER and BLER calculations can be performed by the BTS internally or by an external meter. If the BTS calculates these metrics, the specifications require that it be calibrated using a stimulus signal with inserted errors as shown in Figure 36. The errors must be introduced in such a way that they get spread evenly across all transport channels, and do not concentrate in a single transport channel.

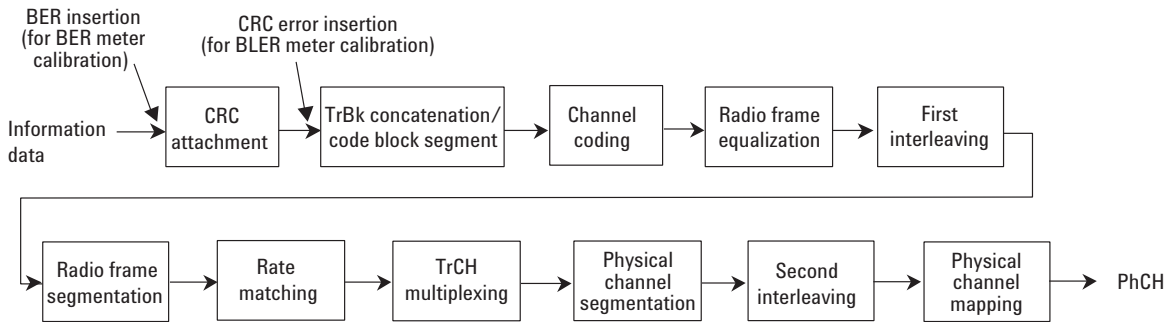

**Figure 36. BER and BLER meter calibration**

The verification of internal BER calculation is part of the receiver characteristics tests and uses the 12.2 kbps reference measurement channel with inserted errors. The verification of internal BLER calculation is part of the RF performance tests and must be performed using all the data rates required for the performance tests (12.2 kbps, 64 kbps, 144 kbps, 384 kbps).

### 2.4.4 Verifying RF performance

The conformance tests verify the performance of the whole BTS design (baseband and RF). However, during the early design stages, RF engineers might be interested in checking only the RF performance (particularly if the baseband is not available). For those cases, it is possible to check BER after descrambling and despreading, at the physical layer. This is known as physical channel BER. Errors can be introduced at the physical layer in the stimulus signal.

### ***2.4.5 Verifying baseband functionality***

The conformance tests verify the performance of the whole BTS design (baseband and RF). However, additional tests that are not part of the specifications are necessary to verify the correct functionality of the receiver baseband for different transport or physical layer parameters.

This requires a stimulus source with the flexibility to modify transport layer parameters such as: block size, number of blocks, coding type, Transmission Time Interval (TTI), data type, rate matching attribute, CRC size and physical layer parameters such as the slot format.

It is also possible to check BER after descrambling and despreading, at the physical layer. This is known as physical channel BER. Errors can be introduced at the physical layer in the stimulus signal. This allows the designer to isolate errors in the descrambling and spreading from errors in the coding.

In addition, baseband functionality must also be verified for different modes of operation or functions. Some examples of this are: compressed mode, PRACH reception, and uplink power control functionality. The following sections provide more detail on these tests.

### ***2.4.6 Verification of compressed mode functionality***

Compressed mode receiver verification requires a stimulus source with the capability to generate fully coded compressed UL DPDCH frames in real time. This enables the BTS to perform BER and BLER tests on compressed mode using continuous, non-truncated PN sequences.

The stimulus source must also allow adjustment of the following parameters that define the configuration of the compressed frame as described in the specifications:

- transmission gap pattern repetition count (TGPRC): number of transmission gap patterns within the transmission gap pattern sequence
- transmission gap connection frame number (TGCFN): connection frame number (CFN) of the first pattern within the transmission gap pattern sequence
- transmission gap slot number (TGSN): slot number of the first transmission gap slot within the first radio frame of the transmission gap pattern
- transmission gap length 1 (TGL1): duration of the first transmission gap within the transmission gap pattern
- transmission gap length 2 (TGL2): duration of the second transmission gap within the transmission gap pattern
- transmission gap duration (TGD): duration of the starting slots of two consecutive transmission gaps within a transmission gap pattern
- transmission gap pattern length 1 (TGPL1): duration of second transmission gap pattern
- transmission gap pattern length 2 (TGPL2): duration of second transmission gap pattern
- stop CFN – CFN of the last radio frame
- transmission gap pattern sequence identifier (TGPSI): establishes a reference to the compressed mode pattern sequence

Figure 37(a) shows an example of the setup for a compressed signal. Figure 37(b) shows the displayed compressed signal. Notice that the power level of the non DTX slots in the compressed frame have a higher power level to compensate for the reduced coding gain.

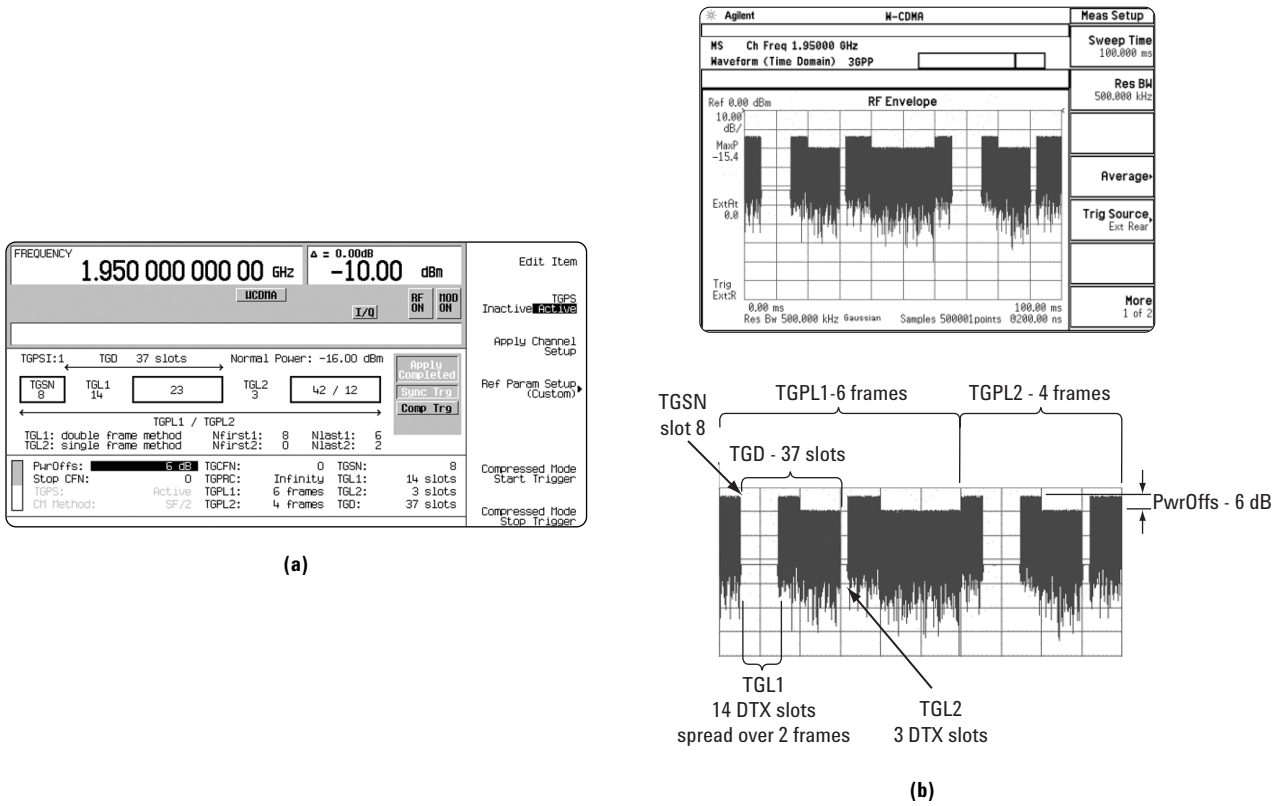

Figure 37. (a) Compressed mode setup and (b) Displayed compressed signal

## 2.4.7 Verification of PRACH reception

As explained in the concepts chapter, the PRACH is used for system access. Therefore, correct PRACH reception functionality is critical to UE performance. In fact, both RACH preamble detection and demodulation of RACH message in both static and multipath conditions tests are required by the current version of Release 4 of the specifications.

A fully coded PRACH signal is required for testing PRACH reception. Configurable timing and selectable signature for the preamble are desirable in order to verify preamble detection for different configurations. For example, one of the most interesting configurations consists of setting up the PRACH signal so that the message part is not transmitted until a trigger from an AICH command by the BTS is received. This involves capability in the stimulus source to accept some sort of trigger signal for the message part.

Testing PRACH reception under multiple PRACH transmission is also necessary to verify the ability of the BTS to detect PRACHs from different UEs. This requires a source capable of simulating multiple UEs attempting to contact a BTS. Particularly interesting is overloading testing with multiple PRACHs. This might required more than one signal source, each transmitting multiple PRACHs. Figure 38(a) shows an access slot setup for a signal with three preambles (notice that UE3 is off). Figure 38(b) shows the displayed three-PRACH signal.

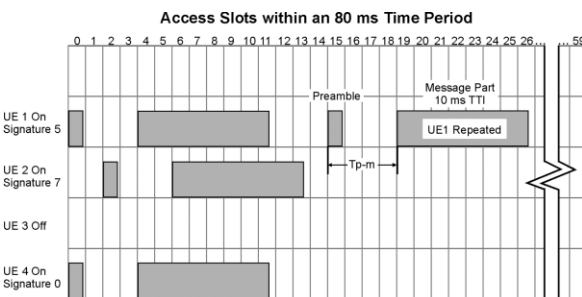
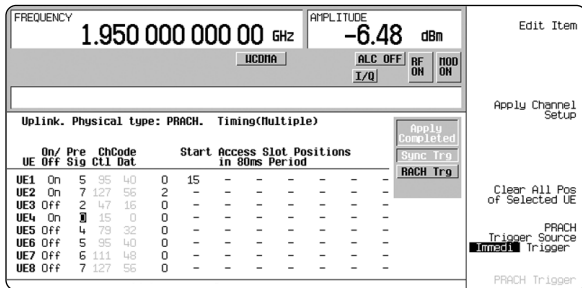

(a)

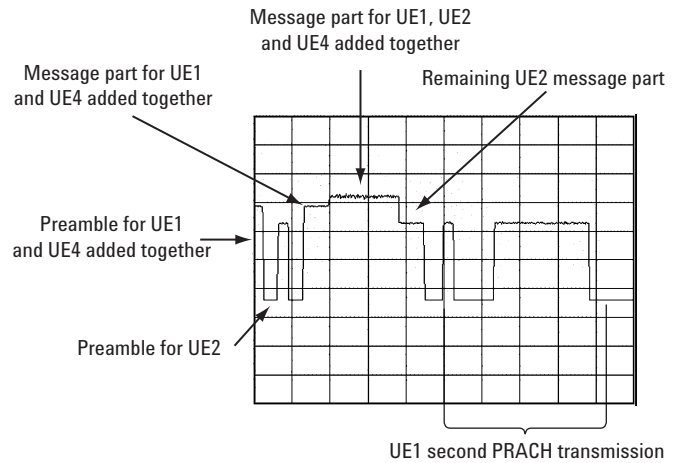

(b)

Figure 38. (a) Access slot setup and timing for multiple PRACHs and (b) Transmitted multiple PRACH signal.

### 2.4.8 Verification of uplink power control

The BTS can always minimize the transmission power against the required quality at the receiver by transmitting TPC commands based on SIR measurements. This maximizes total system capacity. Power control at each slot is needed to keep the received signal quality constant under fading conditions.

Verifying the BTS real-time power control function (the BTS capability to appropriately measure receiver SIR and generate TPC commands accordingly) requires the signal source to simulate the UE by generating a signal that changes its power upon reception of different input levels that correspond to TPC commands from the BTS.

### 3. Special Considerations for Femtocells

As service providers begin mass deployment of femtocells, manufacturers face unprecedented challenges to deliver quality, low-cost devices to market. Femtocells are subject to 3GPP's rigorous verification and conformance documents, as well as stringent new requirements on interference and compatibility with the broader network where they are used. During development, the same measurements as described above will be used, though the specification limits may be different in some cases due to the lower output power of the device. Designers must also be aware that achieving cost goals comparable with Wireless LAN access points will be a huge challenge in manufacturing, and one of the main drivers will be the way the product is initially designed.

While a normal network base station will have assigned operating parameters and be installed by a dedicated team of engineers, femtocells are designed to be switched on and operated by anyone, and must work without causing network problems (See Figure 39). Therefore, in addition to typical functionality, they must include simple turn-on procedures and continuous monitoring of the network environment for self-organizing operating frequencies, codes and handovers between the device and the network. To facilitate this, the femtocell may have a “sniffer” – essentially a simplified UE receiver – to allow it to search for base stations and other femtocells operating locally and to determine the scrambling codes they are using. This implies the need for a separate set of receiver tests to verify the sniffer functions correctly.

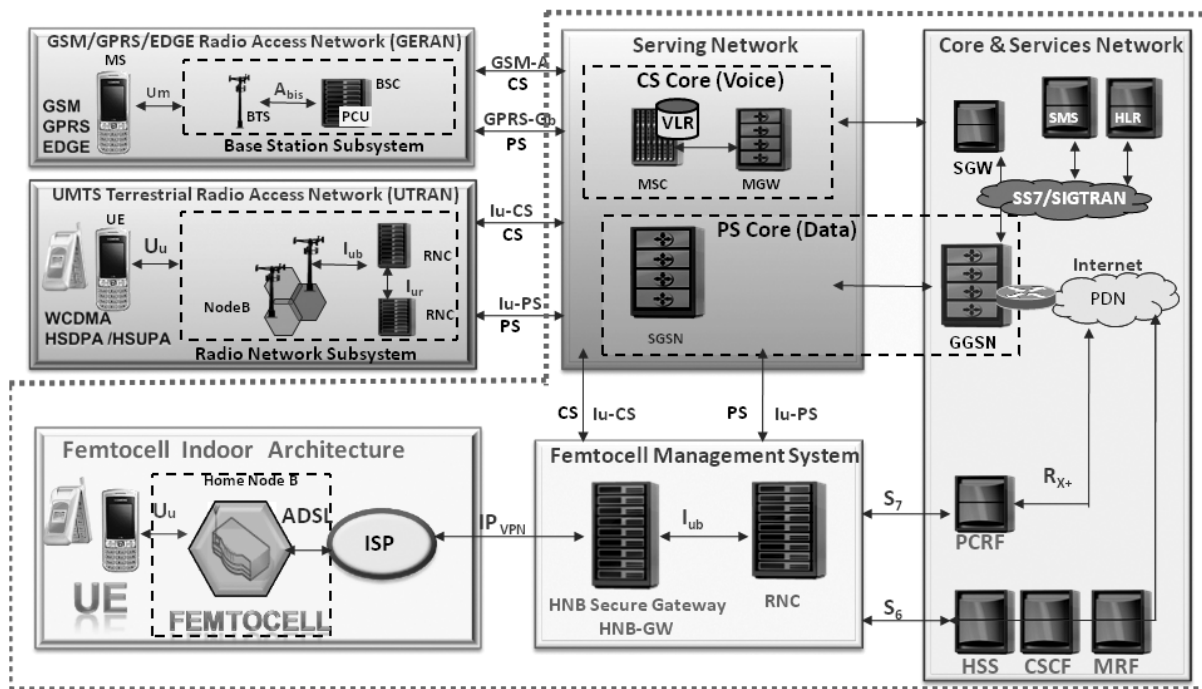

Figure 39. Typical network implementation with femtocell management

Global Positioning System (GPS) is yet another component which will become increasingly important in the femtocell, enabling location assistance for emergency (E911) calls, timing and frequency assistance to provide system clock functionality, and a location licensing capability. With its adoption into the femtocell, verification of GPS functionality has become an increasingly important task. It also offers a way to make the femtocell smart enough so that it can avoid interfering with existing infrastructure and can only be used within the geographical area for which the network operator has a license.



Using GPS within a femtocell presents a number of challenges, since it is less reliable in residential/urban and indoor environments. Assisted GPS (A-GPS) offers one means of addressing this challenge. It improves the accuracy, Time To First Fix (TTFF) and reliability of the GPS receiver by providing assistance data to the GPS receivers through the cellular communication channels.

### 3.1 Additional test requirements for GPS-enabled femtocells

Verification of the GPS receiver performance is typically done using a metric-grade RF signal generator. Five measurements in particular, are especially helpful in verifying GPS receiver performance. These are:

- *Time To First Fix (TTFF)*: The time interval between the GPS receiver startup (power up) and the first-valid navigation 3D-data point, derived from the simulation. GPS receiver TTFF measurements may include cold, warm and hot start configurations.
- *Receiver Sensitivity*: A measure of the signal strength (C/No) under various GPS-signal power levels, as well as the power level and C/No ratio level at which the 3D location fix is lost.
- *Static Navigation Accuracy*: The accuracy of the GPS receiver location fix with respect to the simulated location.
- *Reacquisition Time*: The time required to reacquire a navigation fix following a short blockage of all GPS signals during normal operation.
- *Radio-Frequency Interference*: The GPS receiver's ability to operate in the presence of interfering (jamming) signals that may be received through its input. Note that a second RF source is required to provide the RF interference signal.

## Summary

W-CDMA provides a wideband, dynamically allocatable code space that can provide high data rate communication to many users in a cell. The advanced features of W-CDMA, including its unique acquisition and handover processes, present many challenges in the development, performance verification and production test of W-CDMA systems. This application note provided an overview of some of the key design and test issues for W-CDMA BTSs, including later high-speed extensions (HSPA) and new network elements (femtocells) with new functionality (GPS). It also introduced measurements that can help verify and troubleshoot new designs.

# Appendix A: Conformance Test Setup Tables

Table 4 shows a list of the BTS conformance tests required by the specifications. You can use this table as a quick guideline on what measurements and equipment to use for each test.

Conformance test	3GPP		Measurement solution					Additional comments
	Conf. test section	Test model or reference measurement channel (RMC)	Measurement	Equipment required				
				Signal analyzer	Signal generator	Power meter	Additional parts	
<b>Transmitter tests</b>								
Base station maximum output power	6.2.1	Test model 1	Channel power (or average power)	●		●	Attenuator (Att.)	Either a signal analyzer or a power meter can be used
CPICH power accuracy	6.2.2	Test model 2	Code domain power	●			Att.	
Frequency stability	6.3	Test model 4	Composite EVM or code domain power	●			External ref., att.	
Power control steps	6.4.2	Test model 2	Code domain power	●	●		Att.	
Power control dynamic range	6.4.3	Test model 2	Code domain power	●	●		Att.	
Total power dynamic range	6.4.4	Test model 4	Composite EVM	●		●	Att.	Either a signal analyzer or a power meter can be used
Occupied bandwidth	6.5.1	Test model 1	Occupied bandwidth	●			Att.	
Spectrum emission mask	6.5.2.1	Test model 1	Spectrum emission mask	●			Att.	
Adjacent channel leakage power ratio (ACLR)	6.5.2.2	Test model 1	ACLR or ACPR	●			Att.	
Spurious emissions (Category A)	6.5.3.4.1	Test model 1	Spectrum analysis	●			Att.	
Spurious emissions (Category B)	6.5.3.4.2	Test model 1	Spectrum analysis	●			Att.	
Protection of BTS receiver	6.4.3.4.3	Test model 1	Spectrum analysis	●			Pre-amp filter	
Co-existence with GSM900	6.4.3.4.4	Test model 1	Spectrum analysis	●			Pre-amp filter	
Co-existence with DCS1800	6.4.3.4.5	Test model 1	Spectrum analysis	●			Pre-amp filter	
Co-existence with PHS	6.4.3.4.6	Test model 1	Spectrum analysis	●			Filter	
Co-existence with services in adjacent frequency bands	6.4.3.4.7	Test model 1	Spectrum analysis	●			Filter	
Co-existence with UTRA-TDD	6.4.3.4.8	Test model 1	Spectrum analysis	●			Filter	

**Table 4. Conformance test setup table**

Conformance test	3GPP		Measurement	Measurement solution				Additional comments
	Conf. test section	Test model or reference measurement channel (RMC)		Equipment required				
				Signal analyzer	Signal generator	Power meter	Additional parts	
<b>Transmitter tests</b>								
Transmit intermodulation	6.6	Test model 1	Spectrum analysis	●	●		Combiner, circulator, buffer and terminator	
Modulation accuracy	6.7.1	Test model 4	Composite EVM	●			Att.	
Peak code domain error	6.7.2	Test model 3	Peak code domain error	●			Att.	
<b>Receiver tests</b>								
Reference sensitivity level	7.2	RMC 12.2 kbps	BER		●			
Dynamic range	7.3	RMC 12.2 kbps	BER		●			Requires source with additional AWGN generation
Adjacent channel selectivity	7.4	RMC 12.2 kbps	BER		●		W-CDMA generator combiner and 2 att.	Requires source with ACLR of 63 dB
Blocking characteristics	7.5	RMC 12.2 kbps	BER	●	●		W-CDMA generator or CW generator, combiner, circulator and 3 att.	Requires source with high spectral purity
Intermodulation characteristics	7.6	RMC 12.2 kbps	BER		●		W-CDMA generator, CW generator, 2 combiners and 3 att.	
Spurious emissions	7.7		Manual spectrum monitoring	●				
Verification of internal BER calculation	7.8	RMC 12.2 kbps	BER		●			Sig. gen. must be able to add specified BER to RMC
<b>Performance requirement tests</b>								
Demodulation in static propagation conditions	8.2	RMC 12.2 kbps to 384 kbps	BLER		●		2 AWGN generators, splitters and combiners	
Demodulation of DCH in multipath fading conditions	8.3	RMC 12.2 kbps to 384 kbps	BLER		●		2 Channel simulators, 2 AWGN generators, splitters and combiners	
Demodulation of DCH in moving propagation conditions	8.4	RMC 12.2 kbps and 64 kbps	BLER		●		2 Channel simulators, 2 AWGN generators, splitters and combiners	
Demodulation of DCH in birth/death propagation conditions	8.5	RMC 12.2 kbps and 64 kbps	BLER		●		2 Channel simulators, 2 AWGN generators, splitters and combiners	
Verification of internal BLER calculation	8.6	RMC 12.2 kbps to 384 kbps	BLER		●		1 splitter	Sig. gen. must be able to add specified BER to RMC
RACH performance	8.8	RMC RACH			●			
Performance of signaling detection for HS-DPCCH	8.11	RMC HS-DPCCH			●			
Demodulation of E-DPDCH in multipath fading conditions <sup>2</sup>	8.12	FRC 1-8	BLER (R)		●		2 Channel simulators, 2 AWGN generators, splitters and combiners	Sig. gen. must be able to support HARQ digital feedback signal (ACK/NACK)
Performance of signaling detections for E-DPCCH in multipath fading conditions	8.13	FRC 1&4			●			

**Table 4 (continued). Conformance test setup table**

# Appendix B: Agilent Solutions for W-CDMA BTS Design and Test

This section provides a list of Agilent solutions that you can use to design and test your BTS subsystems and systems.

The diagram in Figure 40 shows a typical R&D test bench for femtocell development testing. Similar equipment would be used for any BTS component test, including Multiple Input Multiple Output (MIMO) scenarios. This would be used in conjunction with a design system seat.

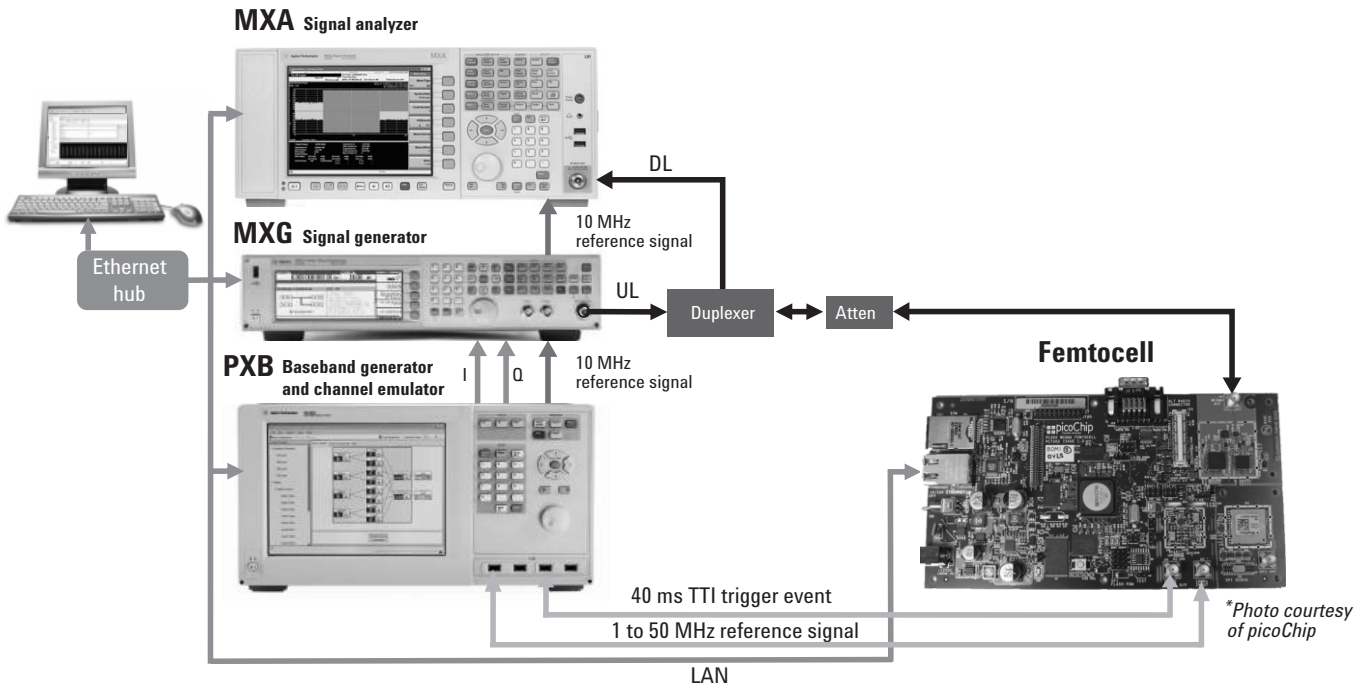

Figure 40. Example of femtocell Tx/Rx RF test setup for R&D

## Software design and simulation

The Agilent Advanced Design System (ADS) can be used to design and verify W-CDMA systems, circuits, and DSP designs. ADS is a versatile design tool that includes a wide array of RF, analog and DSP models and simulation capability.

The 3GPP W-CDMA design library (E8875A) models the physical layer, including the data and control logical channels, frame segmenting and multiplexing forming the coded composite transport channel, and the multiplexing for the dedicated physical data and control channels.

ADS with the E8875A design library option helps you evaluate your designs against key W-CDMA performance parameters such as ACLR, EVM, BER, and BLER early in the design cycle. Many of the transmitter and receiver tests outlined in the specifications can be simulated, as shown in Table 16. Sources set up as Test Model 1-54 are available for transmitter design and verification.

<b>BTS transmitter tests</b>		<b>ADS E8875A</b>
Peak-to-mean for selected channel configuration		X
CCDF for selected channel configuration		X
Transmitter tests:	Transmit power	X
	Max output power	X
	Occupied bandwidth	X
	Out-of-band emission	X
	Spectrum emission mask	X
	Adjacent channel leakage	X
	Modulation accuracy	X
Peak code domain error		X
<b>BTS receiver tests</b>		<b>ADS E8875A</b>
Uncoded physical BER		X
Coded BER and receiver tests:	Reference sensitivity level	X
	Receiver maximum level	X
	Adjacent channel selectivity	X
	Blocking sensitivity	X
	Intermodulation sensitivity	X

**Table 16. Transmitter and receiver tests that can be simulated using the Agilent ADS E8875A**

The E8875A design library also includes signal source configurations similar to those offered in the Agilent E4438C ESG and N5182A MXG vector signal generator.

## Connected solutions

Connectivity between Agilent ADS and Agilent test equipment, such as signal sources and signal analyzers, helps minimize development risk and costs by identifying problems early in the design and fabrication cycle.

W-CDMA system designers can benefit from connected solutions because it can help:

- evaluate system-level performance with partial RF hardware, using simulation to model missing hardware.
- evaluate RF performance (such as BER), using simulation to model missing baseband functionality.
- evaluate system performance more continuously throughout the design/fabrication cycle to help reduce risk and costs.
- evaluate system performance on the testbench with simulated impairments.

W-CDMA component designers benefit from connected solutions because they can use realistic signals for testing that reflect the environment in which the component will be used. Applications include:

- Testing/demonstrating a component DUT. Modeling a transmitter/receiver chain in simulation to show how it would perform in a system.
- Testing/demonstrating a component with various signal formats modeled in simulation.
- Evaluating performance limits of a DUT – how impaired can the input signal be and still meet specifications?

## Signal generation

### *Component testing*

Agilent signal creation software with the E4438C ESG, N5182A MXG and N5106A PXB simulates the 3GPP W-CDMA physical layer. These statistically correct signals are designed to stress W-CDMA handset components and subsystems, just as a real-world signal would. An easy to use interface enables you to:

- Select from several predefined W-CDMA channel configurations, including all the DL test models (1-6), including Home Node B (femtocell)
- Generate up to 32 carriers, for multicarrier component testing
- Setup multicarrier clipping and timing offsets
- Use the table editor to fully configure a W-CDMA multi-channel signal per your requirements

An easy-to-use interface link enables easy download custom waveforms created with ADS into ESG or MXG signal generators.

## Receiver testing

Agilent signal creation software with the E4438C ESG, N5182A MXG and N5106A PXB simulates the transport and physical layers of a 3GPP W-CDMA signal. The transport layer coding enables thorough evaluation of receiver demodulation analysis capabilities at various design stages from components, such as ASICS, to completed receiver designs. The generated signal produces a stream of fully coded W-CDMA/HSPA frames for performing BER and BLER measurements. An easy-to-use interface allows selection from predefined channel configurations, including the reference measurement channels. Key features include:

- Compressed frames
- Add AWGN by setting  $E_c/N_0$  or C/N
- Closed loop power control capability
- 16 OCNS channels
- Flexible configuration of 6 transport layer channels
- Real-time power balancing between the DPCH and OCNS channels
- Closed-loop HARQ feedback
- Closed-loop E-TFC index selection

Test type	TS 25.141 Section	Test description	Agilent signal creation software		
			E4438C-400 <sup>1</sup>	E4438C-419	N7600B
<b>BER and receiver characteristics conformance tests</b>	7.2	Reference sensitivity level	X	X	X
	7.3	Dynamic range	X	X	X
	7.4	Adjacent channel selectivity (ACS)	X	X	X
	7.5	Blocking	X	X	X
	7.6	Intermodulation	X	X	X
	7.8	Verification of the internal BER calculation	X	X	X
<b>BLER and performance requirements tests<sup>2</sup></b>	8.2	Demodulation in static propagation conditions	X	X	X
	8.3	Demodulation of DCH in multipath fading conditions	X	X	X
	8.4	Demodulation of DCH in moving propagation conditions	X	X	X
	8.5	Demodulation of DCH in birth/death propagation conditions	X	X	X
	8.5A	Demodulation of DCH in high speed train conditions	X	X	X
	8.6	Verification of the internal BLER calculation	X	X	X
	8.8	RACH performance	X	–	X
	8.11	Performance of signaling detection for HS-DPCCH	–	X	X
	8.12	Demodulation of E-DPDCH in multipath fading conditions	–	X	X <sup>3</sup>
	8.13	Performance of signaling detections for E-DPCCH in multipath fading conditions	–	X	X
PRACH power ramping			X	–	–
Compressed mode capability			X	X	X

**Table 17. Receiver subsystem, and system tests that can be performed with E4438C ESG or N5182A MXG signal generators**

1. Requires a baseband generator. AWGN capability requires Option 403.

2. N5106A PXB can be used in conjunction with the signal creation software for all performance tests requiring fading.

3. Real-time HARQ feedback not supported.

## Power meters and sensors

The Agilent EPM-P series power meters and E9320 peak and average power sensors provide peak, average and peak to average ratio power measurements on W-CDMA signals. Extensive triggering features are available for making time gated measurements. Fast test times, with a measurement speed of up to 1,000 corrected readings per second, over the GPIB, help increase throughput to meet time to market and time to volume goals. The E9320 peak and average power sensors have a maximum video bandwidth of 5 MHz, ideal for W-CDMA power measurements. High power measurements (average only) of up to 25 W (+44 dBm) are available in the E9300 series.

EPM-P analyzer software is provided with the EPM-P series power meters. This is a PC-based tool for pulse and statistical analysis on TDMA and CDMA modulation formats. For statistical analysis of the power distribution, the EPM-P analyzer software provides the capability to determine the probability density function (PDF), cumulative distribution function (CDF), and CCDF on W-CDMA signals.

Recommended power meters and sensors for 3GPP W-CDMA BTS peak, average and time gated power measurements are:

- EPM-P series power meter E4416A, single channel
- EPM-P series power meter E4417A, dual channel
- E9323A peak and average power sensor, 50 MHz to 6 GHz, 5 MHz video bandwidth, 60 to +20 dBm

All 8480 and E series power sensors are compatible with the EPM-P series power meters.

For average power measurements only, the lower cost EPM series power meters, U2000 Series USB power sensors and other E series power sensors recommended are:

- EPM series power meter N1913A, single channel
- EPM series power meter N1914A, dual channel
- U2001A USB power sensor, 10 MHz to 6 GHz, -60 to +20 dBm
- U2001H USB power sensor, 10 MHz to 6 GHz, -50 to +30 dBm
- U2001B USB power sensor, 10 MHz to 6 GHz, -30 to +44 dBm
- E9301A power sensor, 10 MHz to 6 GHz, 60 to +20 dBm
- E9301H power sensor, 10 MHz to 6 GHz, 50 to +30 dBm
- E9301B power sensor, 10 MHz to 6 GHz, 30 to +44 dBm

Other power sensors in the 8480 series and N8480 series are compatible with the EPM series power meters.

For wide bandwidth power and time measurements, the P-series power meters and sensors provide peak, average, peak-to-average ratio power measurements, time-gated and free-run modes, rise and fall time and pulse width measurements. The range includes:

- EPM-P series power meter N1911A, single channel
- EPM-P series power meter N1912A, dual channel
- N1921A power sensor, 50 MHz to 18 GHz, -35 to +20 dBm
- N1922A power sensor, 50 MHz to 40 GHz, -35 to +20 dBm

The 8480 and E-series power sensors are also compatible with the P-series power meters using adaptor cables. See the on-line configuration guide for details.



## Signal analysis

This table provides a list of Agilent signal analyzers and their W-CDMA BTS transmitter measurement capabilities (as of October 2009).

W-CDMA (3GPP)		Agilent signal analyzers				
Measurements	N9030A PXA N9020A MXA N9010A EXA signal analyzers <sup>1</sup>	N9000A CXA signal analyzer <sup>1</sup>	89600 vector signal analysis software <sup>2</sup>	E444xA PSA series spectrum analyzers <sup>1</sup>	E440xB ESA-E series spectrum analyzers <sup>1</sup>	E7495B field test tool <sup>1</sup>
<b>General purpose measurements</b>						
Channel power	X	X	X <sup>3</sup>	X	X	X
CCDF	X	X	X	X	X	
QPSK EVM	X	X <sup>4</sup>	X	X	X <sup>4</sup>	X
Composite EVM	X	X <sup>4</sup>	X	X	X <sup>4</sup>	X
Code-domain power	X	X <sup>4</sup>	X	X	X <sup>4</sup>	X
Modulation quality						
Peak code domain error	X	X <sup>4</sup>	X	X	X <sup>4</sup>	X
Symbol EVM	X	X <sup>4</sup>	X	X	X <sup>4</sup>	
Symbol power versus time	X	X <sup>4</sup>	X	X	X <sup>4</sup>	
Composite chip power versus time	X	X <sup>4</sup>	X	X	X <sup>4</sup>	
Demodulated bits	X	X <sup>4</sup>	X	X	X <sup>4</sup>	
<b>Transmitter conformance tests</b>						
6.2.1 BTS maximum output power	X	X	X <sup>3</sup>	X	X	X
6.2.2 CPICH power accuracy	X	X <sup>4</sup>	X	X	X <sup>4</sup>	X
6.3 Frequency stability	X	X <sup>4</sup>	X	X	X <sup>4</sup>	X
6.4.1 Inner loop power control and 6.4.2 power control steps	X <sup>3</sup>	X <sup>3.4</sup>	X <sup>3</sup>	X <sup>3</sup>	X <sup>3.4</sup>	
6.4.3 Power control dynamic range	X <sup>3</sup>	X <sup>3.4</sup>	X <sup>3</sup>	X <sup>3</sup>	X <sup>3.4</sup>	
6.4.4 Total power dynamic range	X <sup>3</sup>	X <sup>3.4</sup>	X <sup>3</sup>	X <sup>3</sup>	X <sup>3.4</sup>	
6.5.1 Occupied bandwidth	X	X	X <sup>3</sup>	X	X	X
6.5.2.1 Spectrum emission mask	X	X		X	X	X
6.5.2.2 ACLR	X	X	X <sup>3</sup>	X	X	X
6.5.3 Spurious emissions	X	X <sup>3</sup>		X	X <sup>3</sup>	
6.6 Transmit Intermodulation	X <sup>3</sup>	X <sup>3</sup>		X <sup>3</sup>	X <sup>3</sup>	
6.7.1 Modulation accuracy	X	X <sup>4</sup>	X	X	X <sup>4</sup>	X
6.7.2 Peak code domain error	X	X <sup>4</sup>	X	X	X <sup>4</sup>	X

Table 18. Agilent signal analysis tools for W-CDMA

1. Measurements pre-configured for W-CDMA.
2. Some measurements pre-configured for W-CDMA. Parameters for other measurements must be set up manually as indicated.
3. Measurement parameters must be set up manually.
4. Available with the 89600 software (89601A with options 200, 300 and B7N).

## Power supplies

Network BTS are typically powered by 24 or 48 volt dc power systems, with most of the power being drawn by the RF power amplifier. BTS ratings vary from as little as several watts up to many kilowatts of transmit power. A reliable source of clean dc power with adequate protection features is needed during development testing of valuable BTS and power amplifier prototypes. DC power measurement from the power supply

is used to determine power-added efficiency (PAE). Agilent offers several models out of a large family of single output dc power supplies suited for BTS and power amplifier development testing.

### 6600 Models

<b>Model</b>	6653A	6654A	6032A <sup>1</sup>	6673A	6674A	6683A	6684A	6691A	6692A
<b>Power</b>	500 W	500 W	1 kW	1 kW	2 kW	5 kW	5 kW	6.6 kW	6.6 kW
<b>Max V</b>	35 V	60 V	60 V	35 V	60 V	32 V	40 V	30 V	60 V
<b>Max I</b>	15 A	9 A	50 A	60 A	35 A	160 A	128 A	220 A	110 A

- Notes:**
1. Autoranging topology. Full power from 20 volts to 60 volts.
  2. Identical power supplies can be paralleled for higher current and power.
  3. Additional volt/amp combinations and power levels are available.

### N5700, N6700, N8700 Models

<b>Model</b>	N5745A	N5746A	N5747A	N6765A	N6766A	N6567A	N8735A	N8736A	N8737A	N8755A	N8756A	N8757A
<b>Power</b>	750W	760W	750W	1500W	1520W	1500W	3300W	3400W	3000W	5100W	5000W	5100W
<b>Max V</b>	30V	40V	60V	30V	40V	60V	30V	40V	60V	30V	40V	60V
<b>Max I</b>	25A	19A	12.5A	50A	38A	25A	110A	85A	55A	170A	125A	85A
<b>Height</b>	1U	1U	1U	1U	1U	1U	2U	2U	2U	2U	2U	2U

- Notes:**
1. All new models include USB/LAN/GPIB connectivity.
  2. Additional volt/amp combinations and power levels available.

### *Base station subassembly design and validation*

Basestation PCB and card designers now have an excellent tool for powering and measuring power consumption on base station sub assemblies, including single printed circuit boards for femtocells and picocells as well as traditional base components such as interface cards, timing/control cards, channel baseband processing cards, RF Radio and RF Power Amp assemblies for microcells and macrocells. The N6705A can be used in place of DC-DC converters during the design process and provide multiple DC voltages to backplanes, and includes voltage and current measurements, data logging and arbitrary waveform generation.

# Considerations for femtocell design and test

## Design and development

Femtocell design and development will mainly use the same measurement tools and techniques as for standard classes of base stations, with the addition of UE receiver test to verify the performance of the sniffer function required for auto-setup. In addition, integration of GPS functionality must be verified where required.

The simplified UE receiver used as the sniffer must be able to identify the parameters of all active cells in the area – both other network cells and other femtocells – so that the femtocell setup does not cause interference. Testing the receiver will include only basic functions – sensitivity, frequency and power measurements, demodulation, and the identification of the scrambling codes being used. Design verification will also check interference characteristics such as spurious conducted and radiated emissions.

## Manufacturing test

The volume and cost envelope of the femtocell product needs special attention in manufacturing. As described earlier, it is subject to 3GPP standards definitions and specifications in the same way as other network equipment, so a manufacturing regime that does enough testing to ensure compliance, while at the same time minimizing test time and cost, must be defined.

A typical manufacturing process flow is shown in Figure 41. This type of process essentially relies on full testing of some percentage of the product to give confidence that the process is stable and working correctly, and if the sample fails the entire output will be sent for rework. Most tests will be limited to a subset of possible bands and channel bandwidths where device performance is statistically weakest, which will be determined from data gathered in sample testing.

In early production, a large sample size – up to 100% in pilot production – will be used, with the percentage dropping as confidence in the product and test regime grows, to perhaps 1 in 100 for medium volume mature production and to 1 in 1000 for high volumes.

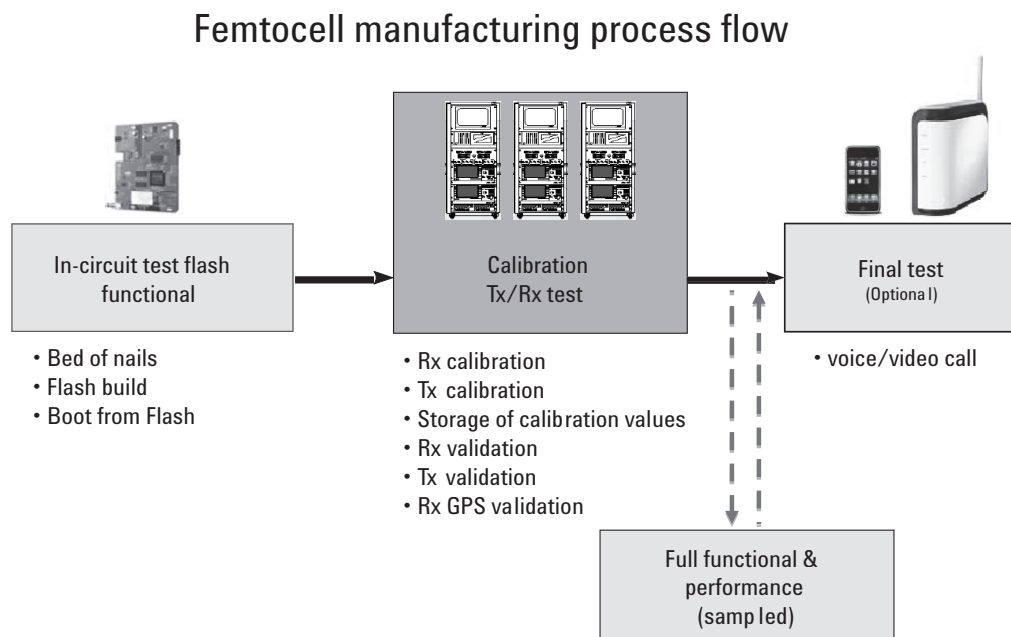
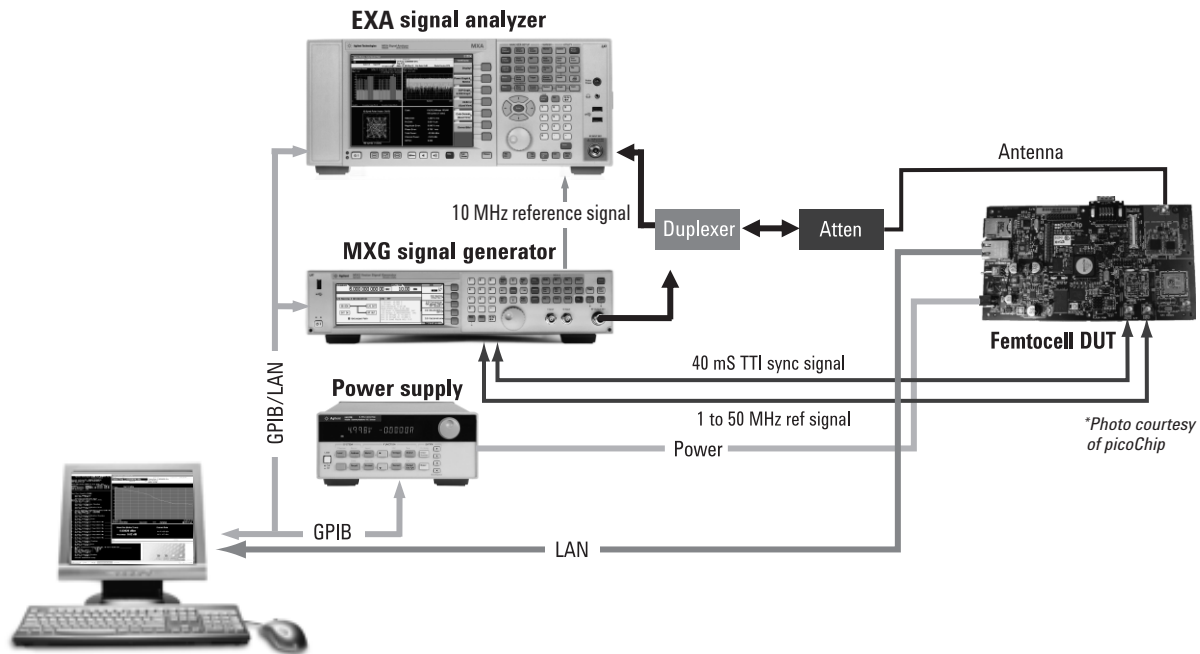

Figure 41. Typical high-volume manufacturing process flow

The equipment used should be adequate to ensure compliance with specifications after taking into account measurement uncertainties, but low enough cost to allow adding test stations as volumes rise. An example, using current Agilent test tools, is shown below. It's likely that the tests required will be a subset of full compliance, for example:

- Channel power: maximum output power
- Code domain: CPICH power accuracy
- Modulation accuracy: frequency error, EVM, peak code domain error
- Power dynamic range
- Occupied bandwidth
- Spectrum emission mask
- ACLR
- Sniffer verification - UE receiver tests
- GPS functional verification



Windows-based PC controller/N7300 series femtocell chipset software

**Figure 42. Typical femtocell production test station**

# Instruments used for measurement examples



Agilent E4438C ESG  
vector signal generator

Agilent PSA series spectrum analyzer or  
E4406A VSA transmitter tester

The following instruments can also be used to make the same measurements:



N9020A MXA signal analyzer



N5182A MXG vector signal generator



N9010A EXA signal analyzer

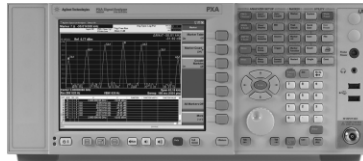

N9030A PXA signal analyzer



N5106A PXB baseband generator and  
channel emulator

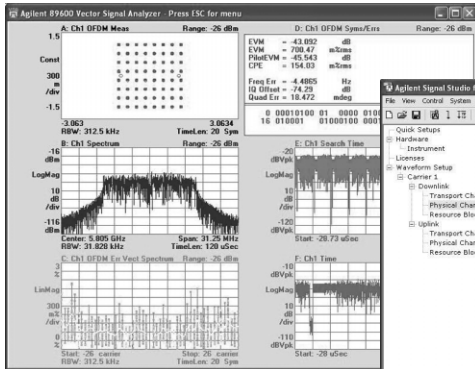

89601A Vector Signal Analysis Software

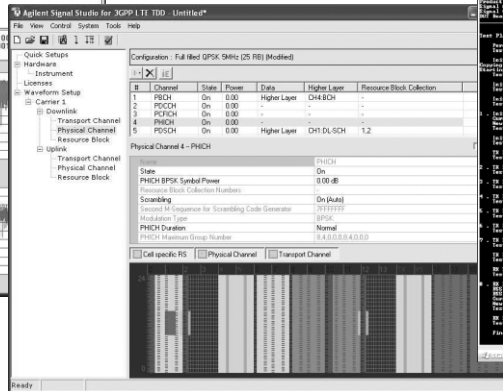

Signal Studio Software

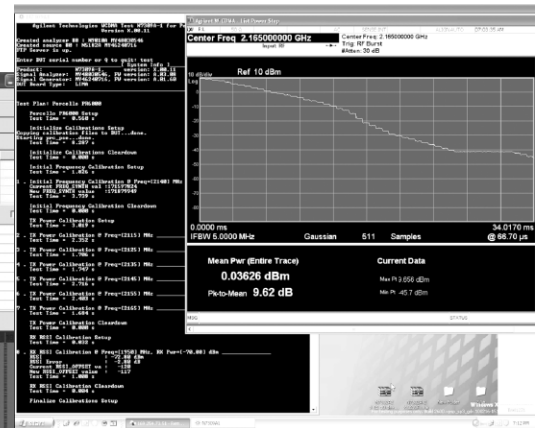

N7300 series femtocell chipset software

**Figure 43.** The measurement examples and screen images in this application note were obtained using the following instruments

Additional information can be found on Agilent's product web sites:

- [www.agilent.com/find/ESG](http://www.agilent.com/find/ESG)
- [www.agilent.com/find/PSA](http://www.agilent.com/find/PSA)
- [www.agilent.com/find/PXA](http://www.agilent.com/find/PXA)
- [www.agilent.com/find/PXB](http://www.agilent.com/find/PXB)
- [www.agilent.com/find/MXA](http://www.agilent.com/find/MXA)
- [www.agilent.com/find/MXG](http://www.agilent.com/find/MXG)
- [www.agilent.com/find/89601A](http://www.agilent.com/find/89601A)
- [www.agilent.com/find/signalstudio](http://www.agilent.com/find/signalstudio)
- [www.agilent.com/find/EXA](http://www.agilent.com/find/EXA)
- [www.agilent.com/find/n7300](http://www.agilent.com/find/n7300)

# Acronym Glossary

2G	Second Generation	I/Q	In-phase/Quadrature
3G	Third Generation	IS-2000	EIA/TIA interim standard 2000 (see cdma 2000)
3GPP	Third-Generation Partnership Project	IS-95	Interim Standard for U.S. Code Division Multiple Access
ACIR	Adjacent Channel Interference Ratio	LO	Local Oscillator
ACL	Adjacent Channel Leakage	MAC	Medium Access Control
ACLR	Adjacent Channel Leakage Power Ratio	MIMO	Multiple Input Multiple Output
ACPR	Adjacent Channel Power Ratio	MISO	Multiple Input Single Output
ACS	Adjacent Channel Selectivity	OCNS	Orthogonal Channel Noise Simulator
AICH	Acquisition Indication Channel	OCQPSK	Orthogonal Complex Quadrature Phase Shift Keying
ARIB	Association of Radio Industries and Businesses (Japan)	OSI	Open System Interconnection
AWGN	Additive White Gaussian Noise	OVSF	Orthogonal Variable Spreading Factor
BCH	Broadcast Channel	PA	Power Amplifier
BCCH	Broadcast Control Channel	PAE	Power-Added Efficiency
BER	Bit Error Rate	PAR	Peak-to-Average Power Ratio
BLER	Block Error Rate	PCH	Paging Channel
BPSK	Binary Phase Shift Keying	PCCH	Paging Control Channel
BTFD	Blind Transport Format Detection	P-CCPCH	Primary Common Control Physical Channel
BTS	Base Transceiver Station	PCPCH	Physical Common Packet Channel
CCCH	Common Control Channel	PDC	Pacific Digital Cellular System
CCDF	Complementary Cumulative Distribution Function	PDF	Probability Density Function
CCTrCH	Coded Composite Transport Channel	PDSCH	Physical Downlink Shared Channel
CDF	Cumulative Density Function	PICH	Paging Indication Channel
CDMA	Code Division Multiple Access	PN	Pseudo-Noise
cdmaOne	Name identifying the EIA/TIA standard (commonly referred to as IS-95) for 2G	PRACH	Physical Random Access Channel
cdma2000	Name identifying the EIA/TIA standard (IS-2000) for 3G	PSC	Primary Synchronization Code
CFN	Connection frame number	P-SCH	Primary Synchronization Channel
C/N	Carrier-to-Noise Ratio	PSK	Phase Shift Keying
CPCH	Common Packet Channel	QAM	Quadrature Amplitude Modulation
CPICH	Common Pilot Channel	QPSK	Quadrature Phase Shift Keying
CQI	Channel Quality Indicator	RACH	Random Access Channel
CRC	Cyclic Redundancy Check	R&D	Research and Development
CW	Continuous Wave (unmodulated signal)	RF	Radio Frequency
DCH	Dedicated Channel	RLC	Radio Link Control
DCCH	Dedicated Control Channel	RMC	Reference Measurement Channel
DL	Downlink	RMS	Root Mean Square
DPCCH	Dedicated Physical Control Channel	RRC	Root Raised Cosine
DPDCH	Dedicated Physical Data Channel	RRC	Radio Resource Control
DQPSK	Differential Quadrature Phase Shift Keying	S-CCPCH	Secondary Common Control Physical Channel
DSP	Digital Signal Processing	SCH	Synchronization Channel
DTCH	Dedicated Traffic Channel	SF	Spreading Factor
DTX	Discontinuous Transmission	SFN	System Frame Number
$E_b/N_o$	Energy-per-Bit-to-Noise Ratio	SIMO	Single Input Multiple Output
$E_c/N_o$	Energy-per-Chip-to-Noise Ratio	SIR	Signal to Interference Ratio
E-DCH	Enhanced Dedicated Channel	SISO	Single Input Single Output
E-DPCCH	Enhanced Dedicated Physical Control Channel	SSC	Secondary Synchronization Code
E-DPDCH	Enhanced Dedicated Physical Data Channel	S-SCH	Secondary Synchronization Channel
ETSI	European Telecommunications Standard Institute	TDD	Time Division Duplex
EVM	Error Vector Magnitude	TDMA	Time Division Multiple Access
FACH	Forward Access Channel	TF	Transport Format
FBI	Feedback Information	TFC	Transport Format Combination
FDD	Frequency Division Duplex	TFCI	Transport Format Control Indicator
FER	Frame Error Ratio	TFCS	Transport Format Combination Set
FRC	Fixed Reference Channel	TGPRC	Transmission Gap Pattern Repetition Count
GMSK	Gaussian Minimum Shift Keying	TGCFN	Transmission Gap Connection Frame Number
GPS	Global Positioning System	TGSN	Transmission Gap Slot Number
GSM	Global System for Mobile Communications	TGL1	Transmission Gap Length 1
HARQ	Hybrid Automatic Repeat Request	TGL2	Transmission Gap Length 2
HPSK	Hybrid Phase Shift Keying	TGD	Transmission Gap Duration
HSDPA	High Speed Downlink Packet Access	TGPL1	Transmission Gap Pattern Length 1
HS-DPCCH	High Speed Dedicated Physical Control Channel	TGPL2	Transmission Gap Pattern Length 2
HS-DSCH	High Speed Downlink Shared Channel	TGPSI	Transmission Gap Pattern Sequence Identifier
HSPA	High Speed Packet Access	TIA	Telecommunications Industries Association (U.S.)
HS-PDSCH	High Speed Physical Downlink Shared Channel	TPC	Transmit Power Control
HS-SCCH	High Speed Shared Control Channel for HS-DSCH	TTA	Telecommunications Technology Association (Korea)
HSUPA	High Speed Uplink Packet Access	TTC	Telecommunication Technology Committee (Japan)
IF	Intermediate Frequency	TTI	Transmission Time Interval
IMT-2000	International Mobile Telecommunications-2000 (Collective name for 3G technologies approved by the ITU)	UE	User Equipment
		UL	Uplink
		UMTS	Universal Mobile Telephone System (Europe)
		W-CDMA	Wideband-Code Division Multiple Access (3G system)

## References

3rd Generation Partnership Project, Technical Specification Group Radio Access Network, Releases 99 through 8:

- Base Station Conformance Specification. Radio Transmission and Reception (FDD). TS 25.141.
- Multiplexing and Channel Coding (FDD). TS 25.212.
- Medium Access Control Protocol Specification. TS 25.321.
- Radio Link Control Protocol Specification. TS 25.322.
- Radio Resource Control Protocol Specification. TS 25.331.
- Radio Interface Protocol Architecture. TS 25.301.
- Physical Layer: Physical Channels and Mapping of Transport Channels onto Physical Channels (FDD). TS 25.211
- Physical Layer: Spreading and Modulation (FDD). TS 25.213.
- Physical Layer: Channel Coding and Multiplexing Examples. TS 25.944.
- BS Radio Transmission and Reception (FDD). TS 25.104
- UTRAN Overall Description. TS 25.401

3rd Generation Partnership Project. Technical Specification Group Terminal; Terminal Conformance Specification. Radio Transmission and Reception (FDD). Release 99. TS 34.121

### Agilent Technologies references:

- HPSK Spreading for 3G*, Application Note 1335, literature number 5968-8438E.
- Fundamentals of RF and Microwave Power Measurements*, Application Note 64-1C, literature number 5965-6630E.
- Characterizing Digitally Modulated Signals with CCDF Curves*, Application Note, literature number 5968-6875E.
- Testing and Troubleshooting Digital RF Communications Transmitter Designs*, Application Note 1313, literature number 5968-3578E.
- Testing and Troubleshooting Digital RF Communications Receiver Designs*, Application Note 1314, literature number 5968-3579E.

## Related Agilent Literature

- 3GPP W-CDMA Design Library*, literature number 5980-0953E.
- MXA Signal Analyzers Brochure*, literature number 5989-5047EN.
- EXA Signal Analyzer Brochure*, literature number 5989-6527EN.
- MXG Signal Generators Brochure*, literature number 5989-5074EN.
- PXA High Performance Signal Analyzer Brochure*, literature number 5990-3951EN.
- PXB Baseband Generator and Channel Emulator Brochure*, literature number 5989-8970EN.
- PSA Series Performance Spectrum Analyzers Brochure*, literature number 5980-1283E.
- ESA-E Series Spectrum Analyzers Brochure*, literature number 5968-3278E.
- ESA Instrument Connected Solutions Configuration Guide*, literature number 5988-6561EN.
- EPM Series Power Meters Brochure*, literature number 5965-6380E.
- EPM-P Series Single - and Dual - Channel Power Meters/ E9320 Family of Peak and Average Power Sensors Product Overview*, literature number 5980-1471E.
- 89600 Series Wide Bandwidth Vector Signal Analyzers*, literature number 5980-0723E.
- E4438C ESG Vector Signal Generator Brochure*, literature number 5988-3935EN.
- Family of DC Power Supplies Brochure*, literature number 5988-2384EN.
- E7495B Base Station Test Set Technical Overview*, literature number 5988-7186EN.

# Web Resources

For additional product information and literature, visit our Web sites:

[www.agilent.com/find/ESG](http://www.agilent.com/find/ESG)  
[www.agilent.com/find/PSA](http://www.agilent.com/find/PSA)  
[www.agilent.com/find/PXA](http://www.agilent.com/find/PXA)  
[www.agilent.com/find/PXB](http://www.agilent.com/find/PXB)  
[www.agilent.com/find/MXA](http://www.agilent.com/find/MXA)  
[www.agilent.com/find/MXG](http://www.agilent.com/find/MXG)  
[www.agilent.com/find/89601A](http://www.agilent.com/find/89601A)  
[www.agilent.com/find/signalstudio](http://www.agilent.com/find/signalstudio)



## Agilent Email Updates

[www.agilent.com/find/emailupdates](http://www.agilent.com/find/emailupdates)  
Get the latest information on the products and applications you select.



## [www.lxistandard.org](http://www.lxistandard.org)

LXI is the LAN-based successor to GPIB, providing faster, more efficient connectivity. Agilent is a founding member of the LXI consortium.

## Agilent Channel Partners

[www.agilent.com/find/channelpartners](http://www.agilent.com/find/channelpartners)  
Get the best of both worlds: Agilent's measurement expertise and product breadth, combined with channel partner convenience.



Agilent Advantage Services is committed to your success throughout your equipment's lifetime. We share measurement and service expertise to help you create the products that change our world. To keep you competitive, we continually invest in tools and processes that speed up calibration and repair, reduce your cost of ownership, and move us ahead of your development curve.

[www.agilent.com/find/advantageservices](http://www.agilent.com/find/advantageservices)



[www.agilent.com/quality](http://www.agilent.com/quality)

[www.agilent.com](http://www.agilent.com)  
[www.agilent.com/find/wcdma](http://www.agilent.com/find/wcdma)

For more information on Agilent Technologies' products, applications or services, please contact your local Agilent office. The complete list is available at:

[www.agilent.com/find/contactus](http://www.agilent.com/find/contactus)

### Americas

Canada	(877) 894 4414
Brazil	(11) 4197 3500
Latin America	305 269 7500
Mexico	01800 5064 800
United States	(800) 829 4444

### Asia Pacific

Australia	1 800 629 485
China	800 810 0189
Hong Kong	800 938 693
India	1 800 112 929
Japan	0120 (421) 345
Korea	080 769 0800
Malaysia	1 800 888 848
Singapore	1 800 375 8100
Taiwan	0800 047 866
Thailand	1 800 226 008

### Europe & Middle East

Austria	43 (0) 1 360 277 1571
Belgium	32 (0) 2 404 93 40
Denmark	45 70 13 15 15
Finland	358 (0) 10 855 2100
France	0825 010 700*
	*0.125 €/minute
Germany	49 (0) 7031 464 6333
Ireland	1890 924 204
Israel	972-3-9288-504/544
Italy	39 02 92 60 8484
Netherlands	31 (0) 20 547 2111
Spain	34 (91) 631 3300
Sweden	0200-88 22 55
Switzerland	0800 80 53 53
United Kingdom	44 (0) 118 9276201

Other European Countries:  
[www.agilent.com/find/contactus](http://www.agilent.com/find/contactus)

Revised: July 8, 2010

Product specifications and descriptions in this document subject to change without notice.

© Agilent Technologies, Inc. 2003-2010  
Printed in USA, August 8, 2010  
5980-1239E



Agilent Technologies